

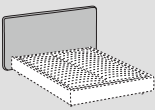







# Claire

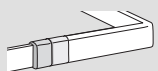

	 Testiera - Headboard	 Giroletto - Bed frame		
<b>Rivestimento Upholstering (6)</b>	Sfoderabile Removable 			
	Non sfoderabile Not removable 	-		
<b>Imbottiture Padding (2-3-4)</b>	 +  D.25kg/m³	 +  D.30kg/m³		

## INFORMAZIONI TECNICHE

### Struttura: 1

Elementi della testiera in abete, fianchi della testiera, longoni e pediera in pannelli di particelle di legno in classe E1 e spessori in pannelli di osb.

### Note:

Per finitura bicolore, considerare il prezzo della categoria più alta dei rivestimenti utilizzati. Possibilità di regolare l'altezza della rete su cui appoggia il materasso nei letti fissi privi di meccanismo.

Caratteristiche relative ai materiali utilizzati descritte nella sezione tecnica a fine listino. Coprirete disponibile nella sezione accessori per letti.

## TECHNICAL INFORMATION

### Structure: 1

Elements of the headboard in pinewood, headboard sides, bed frame sides and footboard in particle board panels in class E1 and particulars in osb panels.

### Note:

For two-colour finish please consider the price of the the highest category of covers used. Height-adjustment option for the bedbase that supports the mattress, allowing total or partial integration for beds without mechanism.

For characteristics of the used materials, see the technical section. Bed-base cover set available in the section "Bed accessories"

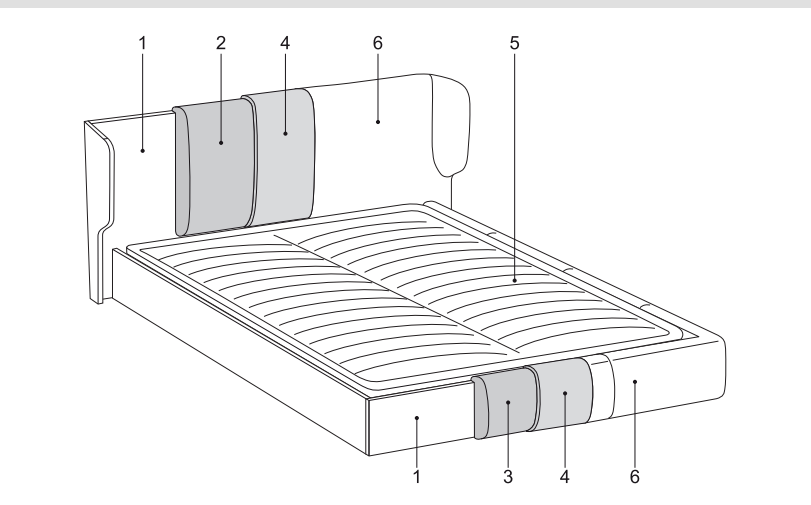

Versioni disponibili (per dimensioni selezionate)

Available versions (by selected dimensions)

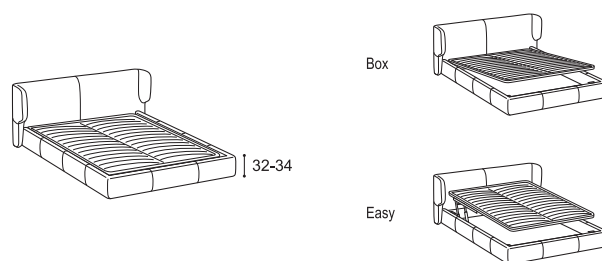









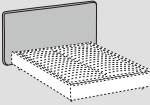

Disponibile per materasso da:  
Available for mattress:



# Claire mix



	 Testiera - Headboard	 Giroletto - Bed frame	
<b>Rivestimento Upholstering (6)</b>	Sfoderabile / Removable -		
	Non sfoderabile / Not removable   / 	-	
<b>Imbottiture Padding (2-3-4)</b>	 +  D.25kg/m³	 +  D.30kg/m³	

## INFORMAZIONI TECNICHE

### Struttura: 1

Elementi della testiera in abete, fianchi della testiera, longoni e pediera in pannelli di particelle di legno in classe E1 e spessori in pannelli di osb.

### Note:

Testiera con fronte rivestito in tessuto, lati e retro testiera piu' giroletto rivestiti in pelle Cat. Soft; per letto con parti in pelle di altre categorie aggiungere la maggiorazione indicata.

Possibilita' di regolare l'altezza della rete su cui appoggia il materasso nei letti fissi privi di meccanismo.

Caratteristiche relative ai materiali utilizzati descritte nella sezione tecnica a fine listino. Coprirete disponibile nella sezione accessori per letti.

## TECHNICAL INFORMATION

### Structure: 1

Elements of the headboard in pinewood, headboard sides, bed frame sides and footboard in particle board panels in class E1 and particulars in osb panels.

### Note:

Headboard with front covered in fabric, sides & back of headboard and bed frame in Soft-category leather; bed-frame upholstery removable. For bed with leather parts from other categories, please add the indicated surcharge.

Height-adjustment option for the bedbase that supports the mattress, allowing total or partial integration for beds without mechanism.

For characteristics of the used materials, see the technical section. Bed-base cover set available in the section "Bed accessories"

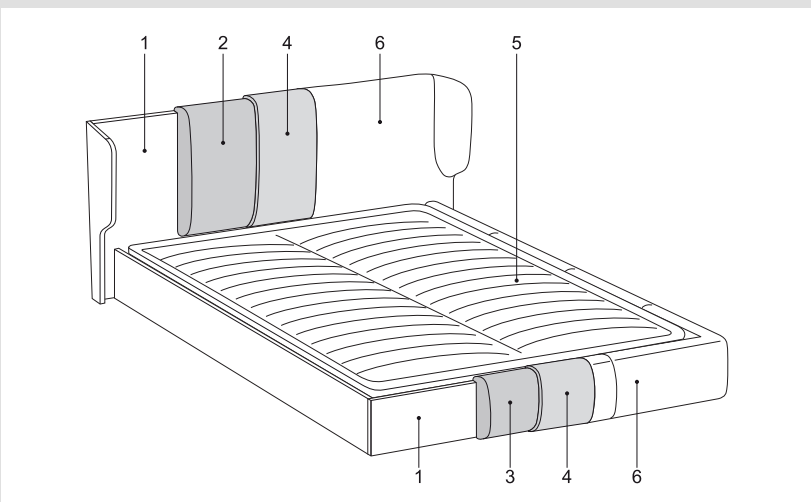

Versioni disponibili (per dimensioni selezionate)

Available versions (by selected dimensions)

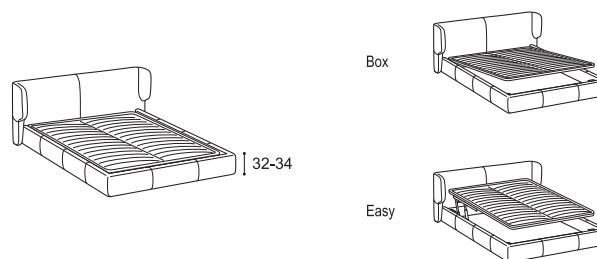

Disponibile per materasso da:  
Available for mattress:

