















Anderson

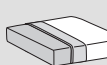

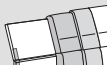
	Sitzkissen - <i>Seduta</i>	Rückenkissen - <i>Schienali</i>	Gestell - <i>Struttura</i>	
Bezug: Rivestimento (8)	abziehbar <i>Sfoderabile</i>	abziehbar <i>Sfoderabile</i>	abziehbar <i>Sfoderabile</i>	
	 	 	 	
	nicht abziehbar <i>Non sfoderabile</i>			
	—			
Polsterungen Imbottiture (5-6-3)	 +  D.30kg/m³	 +  D.18kg/m³	 +  D.18kg/m³	

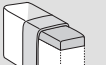
TECHNISCHE BESCHREIBUNG

Gestell: 1

Tragende Elemente aus Tannenholz in verschiedenen Stärken. Teile aus Spanplatten E1 Klasse, Einzelelemente aus Paneelen aus harten Holzfasern oder Zellulose. Korpus vollständig mit Tecnoform bezogen.

Federung: 1-4

Rückenlehne aus harten Holzfasern oder Zellulose. Sitzfläche mit elastischen Gurten aus Propylenfaser und Latex.

Hinweis

Kopfstütze Mechanismus in verchromtem Stahl in 6 Positionen mit manuellem Mechanismus verstellbar (2).

INFORMAZIONI TECNICHE

Struttura: 1

Masselli portanti in abete di vari spessori. Fianchi di tamponamento in pannelli di particelle di legno in classe E1, particolari in pannelli di fibra di legno dura o cellulosa. Struttura rivestita completamente in Tecnoform.

Molleggio: 1-4

Schienale in pannelli di fibra di legno dura o cellulosa. Seduta in nastri elastici di fibra propilenica e lattice.

Note:

Meccanismo del poggiatesta in acciaio cromato regolabile in 6 posizioni con meccanismo manuale (2).

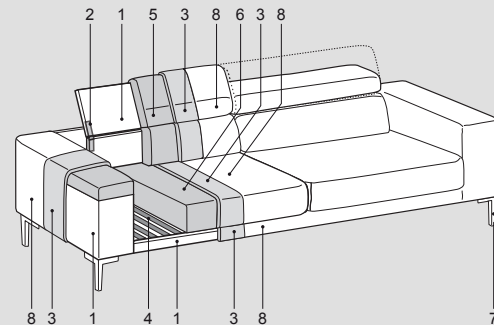
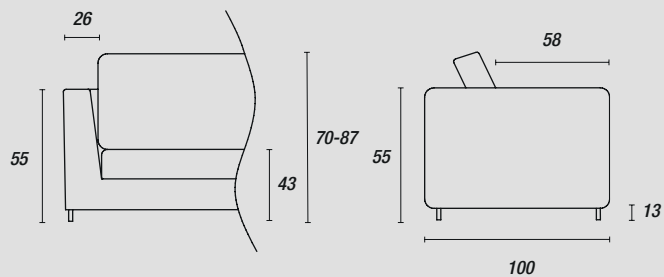

Füße - Piedini:

serienmäßig

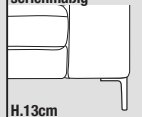

H.13cm
Glänzendes Chrom (ME04)

optional Drink



H.13cm
gegen Aufpreis
Schwarz verchromt (ME05)