















# Bublé

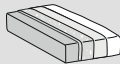

	Sitzkissen - <i>Seduta</i>	Rückenkissen - <i>Schienali</i>	Gestell - <i>Struttura</i>	
<b>Bezug:</b> <b>Rivestimento</b> (9)	abziehbar <i>Sfoderabile</i>			
	  			
	nicht abziehbar <i>Non sfoderabile</i>			
	—	 	 	
<b>Polsterungen</b> <b>Imbottiture</b> (2-3-5-6-7)	 +  D.30kg/m³	 +  D.18kg/m³	 +  Polyurethanschaumstoff	 ETHICALLY SOFT MADE optional

## TECHNISCHE BESCHREIBUNG

### Gestell: 1

Tragende Elemente aus Tannenholz in verschiedenen Stärken. Teile aus Spanplatten E1 Klasse, Einzelelemente aus Paneelen aus harten Holzfasern oder Zellulose.

### Federung: 1-4

Rückenlehne aus harten Holzfasern oder Zellulose.  
Sitzfläche mit elastischen Gurten aus Propylenfaser und Latex.

### Hinweis

Modulare Elemente nicht mit Elementen des Modells Bublé comfort kombinierbar.

## INFORMAZIONI TECNICHE

### Struttura: 1

Masselli portanti in abete di vari spessori. Fianchi di tamponamento in pannelli di particelle di legno in classe E1, particolari in pannelli di fibra di legno dura o cellulosa.

### Molleggio: 1-4

Schienale in pannelli di fibra di legno dura o cellulosa.  
Seduta in nastri elastici di fibra propilenica e lattice.

### Note:

Articoli componibili non abbinabili ad elementi del modello Bublé comfort.

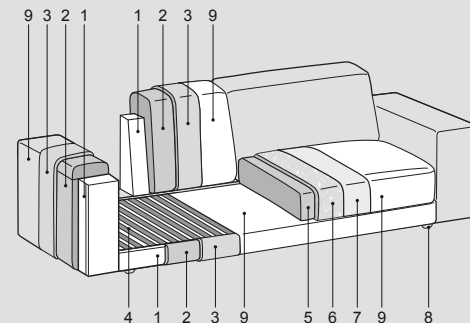
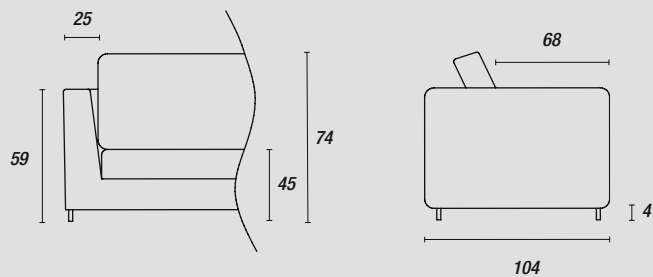

FüÙe: - Piedini::

serienmäßig



H.4cm

Schwarzes Metall (ME09)

# Bubl  comfort



	Sitzkissen - <i>Seduta</i>	R�ckenkissen - <i>Schienali</i>	Gestell - <i>Struttura</i>	
<b>Bezug:</b> <b>Rivestimento</b> (9)	abziehbar <i>Sfoderabile</i> Fabric	Fabric	Fabric	
nicht abziehbar <i>Non sfoderabile</i>	—			
<b>Polsterungen</b> <b>Imbottiture</b> (2-3-5-6-7)	+ D.30kg/m <sup>3</sup>	+ D.18kg/m <sup>3</sup>	+ Polyurethanschaumstoff	 ETHICALLY SOFT MADE optional

## TECHNISCHE BESCHREIBUNG

### Gestell: 1

Tragende Elemente aus Tannenholz in verschiedenen Starken. Teile aus Spanplatten E1 Klasse, Einzelelemente aus Paneelen aus harten Holzfasern oder Zellulose.  
Gestell vollstandig mit Polyurethanschaumstoffplatten und Tecnoform bezogen.

### Federung: 1-4

R ckenlehne aus harten Holzfasern oder Zellulose.  
Sitzflache mit elastischen Gurten aus Propylenfaser und Latex.

### Hinweis

Modulare Elemente nicht mit Elementen des Modells Bubl  kombinierbar.  
Um die R ckenlehne zu heben, gibt es ein Mechanismus aus hochresistentem Stahl mit Gasfeder.

## INFORMAZIONI TECNICHE

### Struttura: 1

Masselli portanti in abete di vari spessori. Fianchi di tamponamento in pannelli di particelle di legno in classe E1, particolari in pannelli di fibra di legno dura o cellulosa.  
Struttura rivestita completamente in lastre di poliuretano espanso e Tecnoform.

### Molleggio: 1-4

Schienale in pannelli di fibra di legno dura o cellulosa.  
Seduta in nastri elastici di fibra propilenica e lattice.

### Note:

Articoli componibili non abbinabili ad elementi del modello Bubl .  
Meccanismo alzaschienale in acciaio ad alta resistenza con molla a gas.

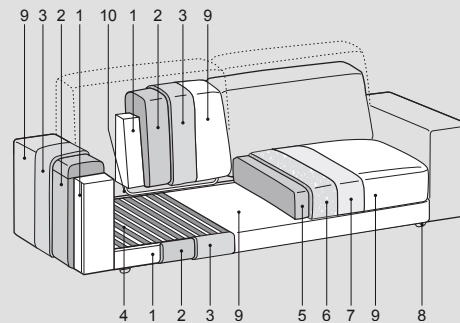
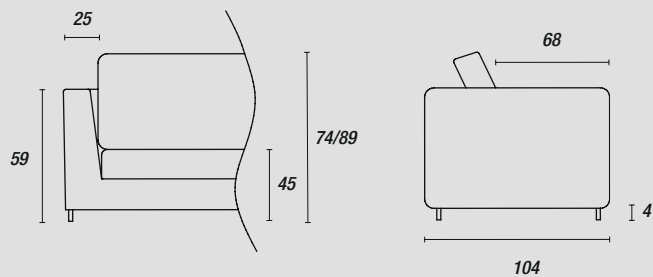

F  e - Piedini:

serienma ig



Schwarzes Metall (ME09)