













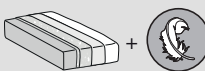

	Sitzkissen - <i>Seduta</i>	Rückenkissen - <i>Schienali</i>	Gestell - <i>Struttura</i>	
Bezug: Rivestimento (10)	abziehbar <i>Sfoderabile</i>   	  		
nicht abziehbar <i>Non sfoderabile</i>	—	—	 	
Polsterungen Imbottiture (3-4-6-7-8-9)	 D.35kg/m³	 D.18kg/m³	 Polyurethanschaumstoff Tecniform	 ETHICALLY SOFT MADE optional

TECHNISCHE BESCHREIBUNG

Gestell: 1-2

Tragende Struktur aus Mehrschichtplatte und Tannenholz.

Federung: 1-5

Rückenlehne aus Mehrschichtplatte.

Sitzfläche mit elastischen Gurten aus Propylenfaser und Latex.

Hinweis

Der Fuß DUAL ragt 3 cm über der Armlehne heraus. Mit dem Fuß DUAL verändern sich die Abmessungen der Elemente entsprechend.

INFORMAZIONI TECNICHE

Struttura: 1-2

Struttura portante in pannelli di legno listellare multistrato e masselli portanti in abete di vari spessori.

Molleggio: 1-5

Schienale in pannelli di legno multistrato.

Seduta in nastri elastici di fibra propilenica e lattice.

Note:

Il piedino DUAL sporge di 3cm dal bracciolo, con il piedino DUAL le dimensioni degli elementi di conseguenza variano.

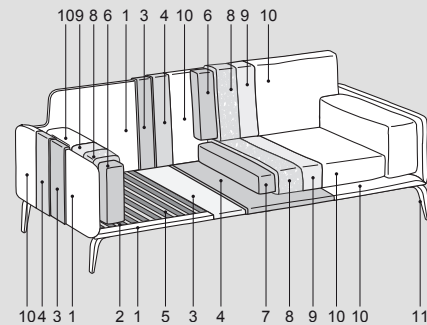
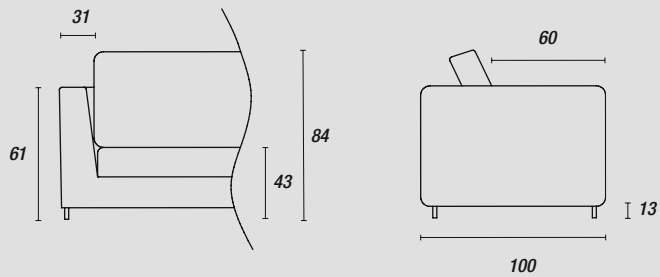

Füße - Piedini:

serienmäßig BJORG



Schwarzes Metall (ME09)
Light brown (ME11)
Anthrazit (ME01)
Dunkelbraun (ME03)

optional Bjorg



gegen Aufpreis
Glänzendes Chrom (ME04)
Schwarz verchromt (ME05)

optional DUAL

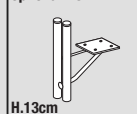

gegen Aufpreis
Schwarzes Metall (ME09)

optional UP

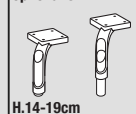

gegen Aufpreis
Schwarzes Metall (ME09)
Light brown (ME11)





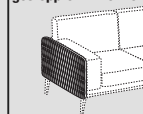

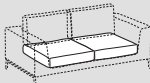
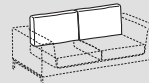
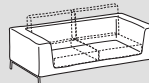

Zubehör - Accessori:

gesteppte Armlehne

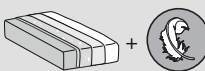

Kris Mix



	 Sitzkissen - <i>Seduta</i>	 Rückenkissen - <i>Schienali</i>	 Gestell - <i>Struttura</i>	
Bezug: Rivestimento (10)	abziehbar <i>Sfoderabile</i> 		-	
	nicht abziehbar <i>Non sfoderabile</i> -	-		
Polsterungen Imbottiture (3-4-6-7-8-9)	 D.35kg/m³	 D.18kg/m³	 Polyurethanschaumstoff Tecnoform	 ETHICALLY SOFT MADE optional

TECHNISCHE BESCHREIBUNG

Gestell: 1-2

Tragende Struktur aus Mehrschichtplatte und Tannenholz.

Federung: 1-5

Rückenlehne aus Mehrschichtplatte.

Sitzfläche mit elastischen Gurten aus Propylenfaser und Latex.

Hinweis

Korpus in Leder Kat. Soft; für Polsterartikel mit Lederteilen anderer Kategorien den angegebenen Zuschlag hinzufügen.

Der Fuß DUAL ragt 3 cm über der Armlehne heraus. Mit dem Fuß DUAL verändern sich die Abmessungen der Elemente entsprechend.

INFORMAZIONI TECNICHE

Struttura: 1-2

Struttura portante in pannelli di legno listellare multistrato e masselli portanti in abete di vari spessori.

Molleggio: 1-5

Schienale in pannelli di legno multistrato.

Seduta in nastri elastici di fibra propilenica e lattice.

Note:

Scocca rivestita in pelle Cat. Soft; per articolo imbottito con parti in pelle di altre categorie, aggiungere la maggiorazione indicata.

Il piedino DUAL sporge di 3cm dal bracciolo, con il piedino DUAL le dimensioni degli elementi di conseguenza variano.

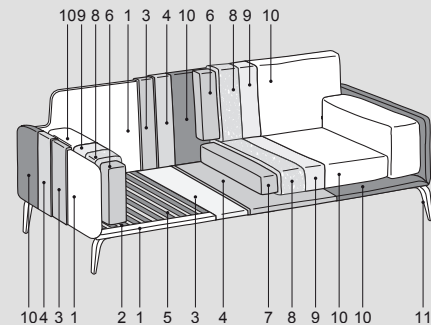
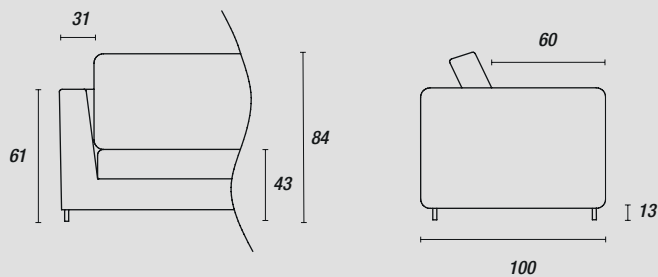

Füße - Piedini:

serienmäßig BJORG



H.13cm
Schwarzes Metall (ME09)
Light brown (ME11)
Anthrazit (ME01)
Dunkelbraun (ME03)

optional Bjorg



gegen Aufpreis
Glänzendes Chrom (ME04)
Schwarz verchromt (ME05)

optional DUAL

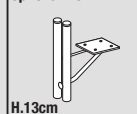

gegen Aufpreis
Schwarzes Metall (ME09)

optional UP

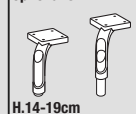

gegen Aufpreis
Schwarzes Metall (ME09)
Light brown (ME11)





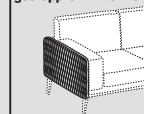







Zubehör - Accessori:

gesteppte Armlehne

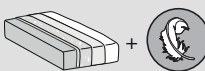

Kris Low



	Sitzkissen - Seduta	Rückenkissen - Schienali	Gestell - Struttura	
Bezug: Rivestimento (10)	abziehbar <i>Sfoderabile</i>   	  		
nicht abziehbar <i>Non sfoderabile</i>	—	—	 	
Polsterungen Imbottiture (3-4-6-7-8-9)	 D.35kg/m³	 D.18kg/m³	 Polyurethanschaumstoff	 optional

TECHNISCHE BESCHREIBUNG

Gestell: 1-2

Tragende Struktur aus Mehrschichtplatte und Tannenholz.

Federung: 1-5

Rückenlehne aus Mehrschichtplatte.

Sitzfläche mit elastischen Gurten aus Propylenfaser und Latex.

Hinweis

Der Fuß DUAL ragt 3 cm über der Armlehne heraus. Mit dem Fuß DUAL verändern sich die Abmessungen der Elemente entsprechend.

INFORMAZIONI TECNICHE

Struttura: 1-2

Struttura portante in pannelli di legno listellare multistrato e masselli portanti in abete di vari spessori.

Molleggio: 1-5

Schienale in pannelli di legno multistrato.

Seduta in nastri elastici di fibra propilenica e lattice.

Note:

Il piedino DUAL sporge di 3cm dal bracciolo, con il piedino DUAL le dimensioni degli elementi di conseguenza variano.

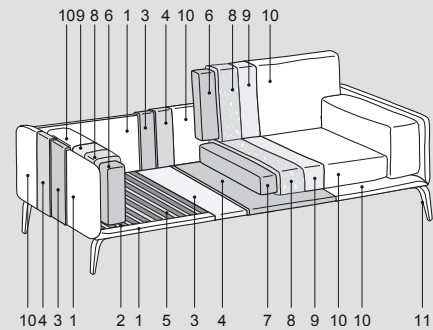
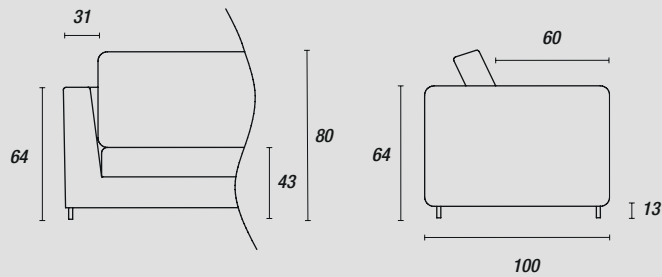

Füße - Piedini:

serienmäßig BJORG



H.13cm
Schwarzes Metall (ME09)
Light brown (ME11)
Anthrazit (ME01)
Dunkelbraun (ME03)

optional Bjorg



H.13cm
gegen Aufpreis
Glänzendes Chrom (ME04)
Schwarz verchromt (ME05)

optional DUAL

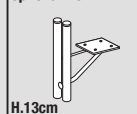

H.13cm
gegen Aufpreis
Schwarzes Metall (ME09)

optional UP

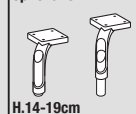

H.14-19cm
gegen Aufpreis
Schwarzes Metall (ME09)
Light brown (ME11)





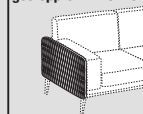

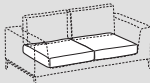
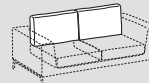
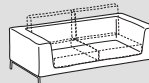

Zubehör - Accessori:

gesteppte Armlehne

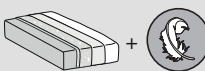

Kris Mix Low



	 Sitzkissen - <i>Seduta</i>	 Rückenkissen - <i>Schienali</i>	 Gestell - <i>Struttura</i>	
Bezug: Rivestimento (10)	abziehbar <i>Sfoderabile</i> 	abziehbar <i>Sfoderabile</i> 	-	
	nicht abziehbar <i>Non sfoderabile</i> -	nicht abziehbar <i>Non sfoderabile</i> -		
Polsterungen Imbottiture (3-4-6-7-8-9)	 D.35kg/m³	 D.18kg/m³	 Polyurethanschaumstoff Tecnoform	 optional

TECHNISCHE BESCHREIBUNG

Gestell: 1-2

Tragende Struktur aus Mehrschichtplatte und Tannenholz.

Federung: 1-5

Rückenlehne aus Mehrschichtplatte.

Sitzfläche mit elastischen Gurten aus Propylenfaser und Latex.

Hinweis

Korpus in Leder Kat. Soft; für Polsterartikel mit Lederteilen anderer Kategorien den angegebenen Zuschlag hinzufügen. Borte serienmäßig Ton in Ton, wenn im Kontrast die Farbe angeben.

Der Fuß DUAL ragt 3 cm über der Armlehne heraus. Mit dem Fuß DUAL verändern sich die Abmessungen der Elemente entsprechend.

INFORMAZIONI TECNICHE

Struttura: 1-2

Struttura portante in pannelli di legno listellare multistrato e masselli portanti in abete di vari spessori.

Molleggio: 1-5

Schienale in pannelli di legno multistrato.

Seduta in nastri elastici di fibra propilenica e lattice.

Note:

Scocca rivestita in pelle Cat. Soft; per articolo imbottito con parti in pelle di altre categorie, aggiungere la maggiorazione indicata. Bordo di serie tono su tono, se in contrasto specificare il colore.

Il piedino DUAL sporge di 3cm dal bracciolo, con il piedino DUAL le dimensioni degli elementi di conseguenza variano.

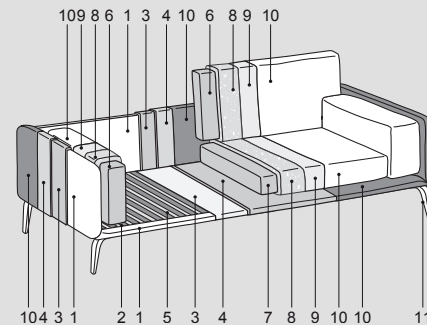
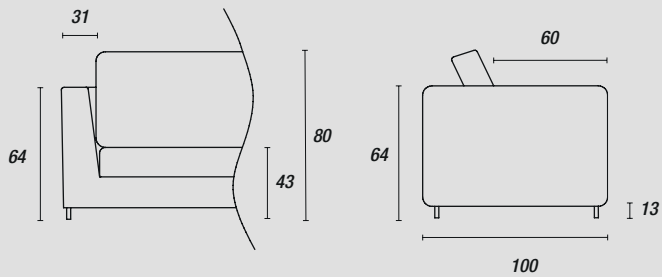

FüÙe: - Piedini::

serienmäßig BJORG



H.13cm
Schwarzes Metall (ME09)
Light brown (ME11)
Anthrazit (ME01)
Dunkelbraun (ME03)

optional Bjorg



gegen Aufpreis
Glänzendes Chrom (ME04)
Schwarz verchromt (ME05)

optional DUAL

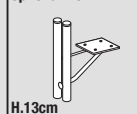

gegen Aufpreis
Schwarzes Metall (ME09)

optional UP

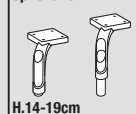

gegen Aufpreis
Schwarzes Metall (ME09)
Light brown (ME11)

Zubehör - Accessori:

gesteppte Armlehne

