



	Seat - Assise	Backrests - Dossiers	Structure - Structure	
Upholstering Revetement (8)	Removable Déhoussable			
	Not removable Non déhoussable	-	-	
Padding Rembourrages (3-4-5-6)				 optional

TECHNICAL INFORMATION

Structure: 1

Supporting structure in pinewood of various thicknesses. Remaining parts in class E1 particleboard panels, hardboard or cellulose wood-based panels details. Structure completely covered by Tecnoform.

Springing: 1-2

The back is made of hard or cellulose wooden fibre panels. The seat is supported by propylene and latex elastic belts.

Note:

For optional stitching "Punto Pettine" please specify thread's colour. Standard side foot bar, metal base or Team foot as an optional; specify the type of foot in the order, surcharges in the opposite page. Metal box and top upholstered in recycled bonded leather.

INFORMATIONS TECHNIQUES

Structure: 1

Structure porteuse en bois de pin de différentes épaisseurs. Autres parties en panneaux de particules de bois en classe E1, détails en panneaux de fibre de bois dure ou cellulose. Structure entièrement revêtue en Tecnoform.

Suspension: 1-2

Dossier en panneaux de fibre de bois dure ou cellulose. Assise avec sangles élastiques de fibre propylénique et latex.

Note:

Pour la couture optionnelle "PUNTO PETTINE", spécifier la couleur du fil. Pied latéral à pont de série, piètement en métal ou pied Team en option; spécifier le nom du pied sur la commande, les majorations sont sur la page opposée. Classeur et plan en métal revêtu en cuir régénéré.

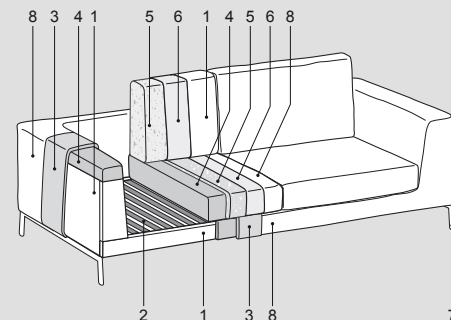
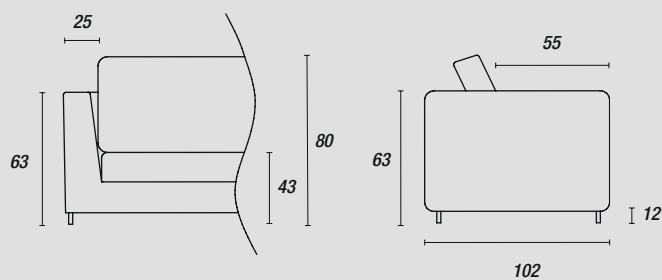

Feet - Pieds::

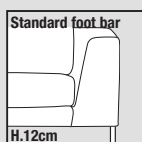

H.12cm
Black (ME09)
Light brown (ME11)
Anthracite (ME01)
Dark brown (ME03)

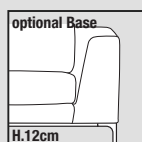

at a surcharge
Black (ME09)
Light brown (ME11)
Anthracite (ME01)
Dark brown (ME03)

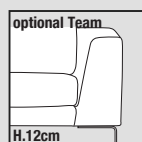

at a surcharge
Black (ME09)
Light brown (ME11)

Accessories - Accessoires:

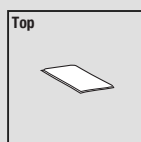

Grey (CR05)
Dark brown (CR08)

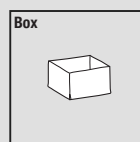

Grey (CR05)
Dark brown (CR08)

