







Flick - Flack

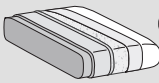

	Seat - Assise	Backrests - Dossiers	Structure - Structure	
Upholstering <i>Revetement</i> (9)	Removable <i>Déhoussable</i>			
	Not removable <i>Non déhoussable</i>	—	—	—
Padding <i>Rembourrages</i> (5-6-7-8)	 D.35kg/m³  memory foam & Tecnoform	 D.30kg/m³	 Polyurethane foam + Tecnoform	 optional

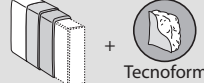
TECHNICAL INFORMATION

Structure: 1-2-3

Supporting structure in pinewood of various thicknesses. Remaining parts in class E1 particleboard panels, hardboard or cellulose wood-based panels details.

Springing: 4-11

The back is supported by propylene and latex elastic belts.
The seat is supported by Nosag-springs.

Note:

The backs (11) have a metal lift/lower mechanism to position the backrest as desired.

INFORMATIONS TECHNIQUES

Structure: 1-2-3

Structure porteuse en bois de pin de différentes épaisseurs. Autres parties en panneaux de particules de bois en classe E1, détails en panneaux de fibre de bois dure ou cellulose.

Suspension: 4-11

Dossier avec bandes élastiques de fibre de propilène et latex.
Assise en ressorts grecs de métal.

Note:

Les dossiers (11) sont équipés d'un mécanisme à friction qui permet la fonction de soulèvement / abaissement du dossier dans la position souhaitée.

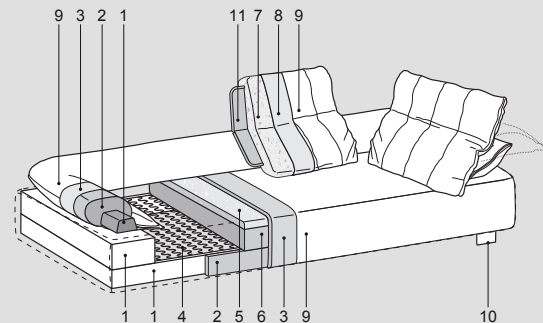
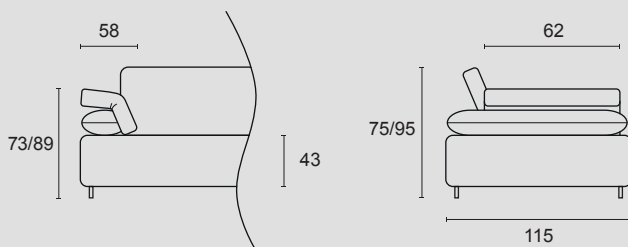

Feet - Pieds::

