











Kanaha

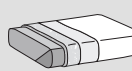

	Seat - Assise	Backrests - Dossiers	Arm-cushion - Coussin pour accoudoir	
Upholstering Revetement (7)	Removable <i>Déhoussable</i>	 	 	 
	Not removable <i>Non déhoussable</i>	—	—	—
Padding Rembourrages (4-5-6-8-9)	 +  D.35/40kg/m³	 Mixed feather	 Mixed feather	 optional

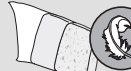
TECHNICAL INFORMATION

Structure: 1-2-3

Steel and wooden particleboard E1 class frame structure covered by interliner.

Springing: 3

The back is made of hard or cellulose wooden fibre panels.
Seat made of hard or cellulose wood fibre panels.

Note:

Armrests (2) are available in recycled bonded leather and, as an optional in these finishes, the back panel too (3), with not removable covering.

The bronzed brown finishing (ME07) of Kanaha is one of a kind, and his peculiarity is the non-uniformity and the continuous chromatic mutation. Upon contact with the material, whose finish is constantly evolving, undergoes a transformation that lead to the achievement of the final coloring in a variable period that depends on the frequency of the utilisation.

INFORMATIONS TECHNIQUES

Structure: 1-2-3

Structure en charpente d'acier et panneaux de particules de bois en classe E1 revetus en velour

Suspension: 3

Dossier en panneaux de fibre de bois dure ou cellulose.
Assise en panneaux de fibre de bois dure ou cellulose.

Note:

Les accoudoirs (2) sont disponibles avec revêtement en cuir régénéré et, en option avec ces finitions, le panneau arrière aussi (3), non déhoussables

La finition marron bronzé (ME07) du Kanaha est unique en son genre, et sa particularité est la non-uniformité et sa continue mutation chromatique. Au contact de la peau le matériel, avec sa finition en constant évolution, subit une transformation qui l'amène à l'obtention de la coloration finale dans une période qui dépend de la fréquence de l'utilisation.

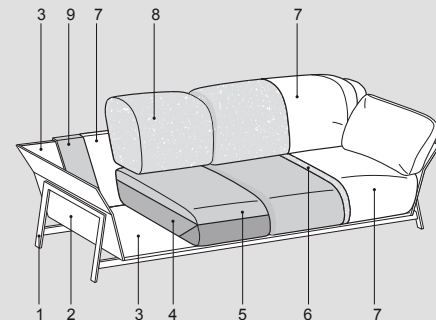
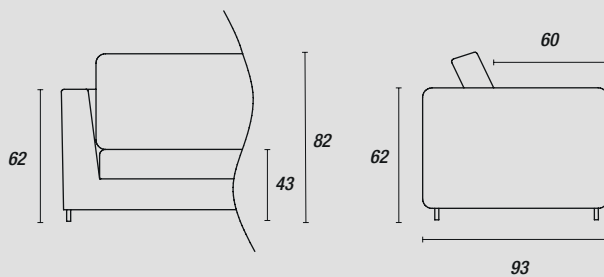

Feet - Pieds::

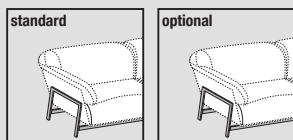

standard
Anthracite (ME01)
Dark brown (ME03)

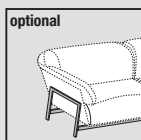

optional
at a surcharge
Bronzed brown finishing (ME07)

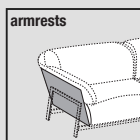

armrests
Brown (CR02)
Taupe (CR03)
Grey (CR05)
Gypsum (CR07)
Dark brown (CR08)

Accessories - Accessoires:

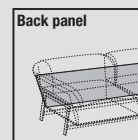

Back panel
Brown (CR02)
Taupe (CR03)
Grey (CR05)
Gypsum (CR07)
Dark brown (CR08)