









Monolith



	Seat - Assise	Backrests - Dossiers	Structure - Structure	
Upholstering <i>Revetement</i> (6)	Removable <i>Déhoussable</i>	 Fabric	 Fabric	 Fabric
	Not removable <i>Non déhoussable</i>	 Artificial Leather	 Artificial Leather	 Artificial Leather
Padding <i>Rembourrages</i> (2-3-4-7-8)	 Tecnoform D.35kg/m³	 Tecnoform D.25kg/m³	 Polyurethane foam	

TECHNICAL INFORMATION

Structure: 1

Supporting structure in pinewood of various thicknesses. Remaining parts in class E1 particleboard panels, hardboard or cellulose wood-based panels details.

Springing: 9

The back is supported by propylene and latex elastic belts.
The seat is supported by propylene and latex elastic belts.

INFORMATIONS TECHNIQUES

Structure: 1

Structure porteuse en bois de pin de différentes épaisseurs. Autres parties en panneaux de particules de bois en classe E1, détails en panneaux de fibre de bois dure ou cellulose.

Suspension: 9

Dossier avec sangles élastiques de fibre propylénique et latex.
Assise avec sangles élastiques de fibre propylénique et latex.

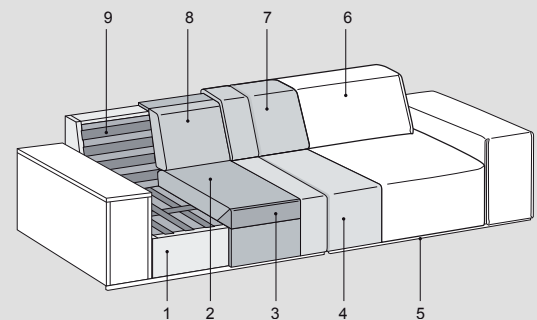
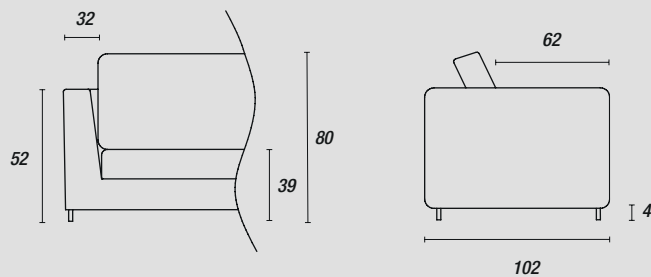

Feet - Pieds::

