

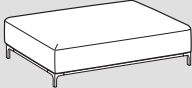









Sanders air



	 Bases - Bases	 Backrests - Dossiers		
Upholstering <i>Déhoussable</i> Revetement (10)	Removable <i>Déhoussable</i>		  	
	Not removable <i>Non déhoussable</i>	 	-	
Padding <i>Rembourrages</i> (3-4-5-6-7-8-9)	 D.35kg/m ³ Tecoform	 D.75/25kg/m ³ + metal weight		 optional

TECHNICAL INFORMATION

Structure: 1

Supporting structure in pinewood of various thicknesses. Remaining parts in Class E1 wood particleboard panels, details in hard wood-based panels.

Springing: 2

The seat is supported by propylene and latex elastic belts.

Note:

* For the leather versions please contact the sales department.

For orders of compositions a sketch is requested.

INFORMATIONS TECHNIQUES

Structure: 1

Structure porteuse en bois de pin de différentes épaisseurs. Autres parties en panneaux de particules de bois en classe E1, détails en panneaux de fibre de bois dure

Suspension: 2

Assise avec sangles élastiques de fibre propylénique et latex.

Note:

* Pour les versions en cuir contactez le service commerciale.

Pour commander une composition c'est nécessaire de nous envoyer une schéma.

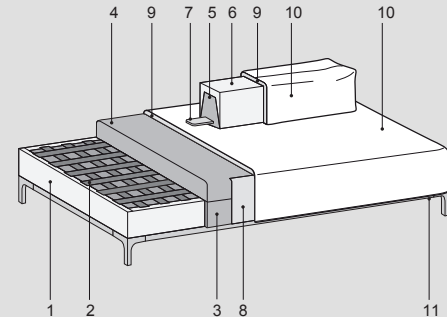
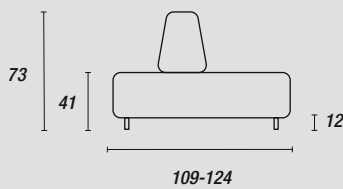

Feet - Pieds::

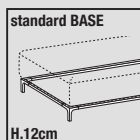

Black (ME09)
Light brown (ME11)
Anthracite (ME01)
Dark brown (ME03)

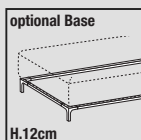

at a surcharge
Shining Chromium (ME04)

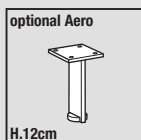





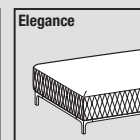
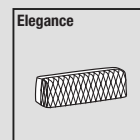



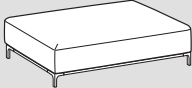

Black (ME09)
Light brown (ME11)

Accessories - Accessoires:

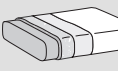

Sanders air mix



	 Bases - Bases	 Backrests - Dossiers	
Upholstering <i>Déhoussable</i> Revetement (10)	Removable <i>Déhoussable</i> —	 	
	Not removable <i>Non déhoussable</i>	 	—
Padding <i>Rembourrages</i> (3-4-5-6-7-8)	  D.35kg/m ³	  D.75/25kg/m ³ + metal weight	 optional

TECHNICAL INFORMATION

Structure: 1

Supporting structure in pinewood of various thicknesses. Remaining parts in Class E1 wood particleboard panels, details in hard wood-based panels.

Springing: 2

The seat is supported by propylene and latex elastic belts.

Note:

Base upholstered in fabric and partially upholstered in leather Soft category; for the upholstery in other leather categories, please add the indicated increase in price.

For orders of compositions a sketch is requested.

INFORMATIONS TECHNIQUES

Structure: 1

Structure porteuse en bois de pin de différentes épaisseurs. Autres parties en panneaux de particules de bois en classe E1, détails en panneaux de fibre de bois dure

Suspension: 2

Assise avec sangles élastiques de fibre propylénique et latex.

Note:

Base revêtue en tissu et partiellement revêtue en cuir catégorie Soft; pour l'article rembourré avec des parties dans d'autres catégories de cuir, rajouter la majoration qui est indiquée.

Pour commander une composition c'est nécessaire de nous envoyer un schéma.

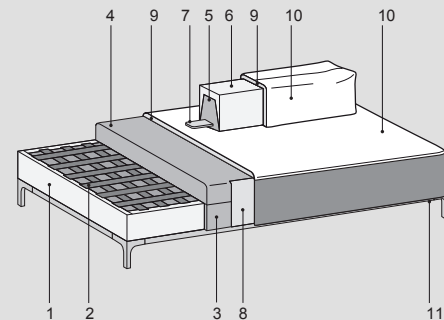
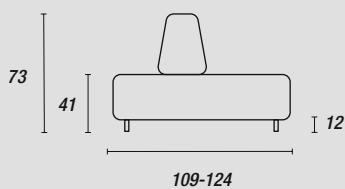

Feet - Pieds::

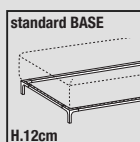

Black (ME09)
Light brown (ME11)
Anthracite (ME01)
Dark brown (ME03)

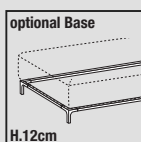

at a surcharge
Shining Chromium (ME04)

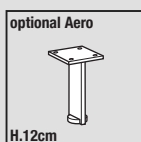

Black (ME09)
Light brown (ME11)

Accessories - Accessoires:

