

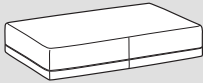











Sanders

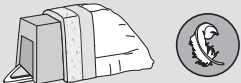

	 Bases - Bases	 Backrests - Dossiers	 Armrest - Accoudoir		
Upholstering <i>Revetement</i> (7)	Removable <i>Déhoussable</i>		  		
	Not removable <i>Non déhoussable</i>		-		
Padding <i>Rembourrages</i> (2-3-4-5-6-10-11)	 D.35kg/m³	 D.75/25kg/m²+ metal weight	 Polyurethane foam	 optional	

TECHNICAL INFORMATION

Structure: 1

Supporting structure in pinewood of various thicknesses. Remaining parts in Class E1 wood particleboard panels, details in hard wood-based panels.

Springing: 8

The seat is supported by propylene and latex elastic belts.

Note:

For orders of compositions a sketch is requested.

INFORMATIONS TECHNIQUES

Structure: 1

Structure porteuse en bois de pin de différentes épaisseurs. Autres parties en panneaux de particules de bois en classe E1, détails en panneaux de fibre de bois dure

Suspension: 8

Assise avec sangles élastiques de fibre propylénique et latex.

Note:

Pour commander une composition c'est nécessaire de nous envoyer une schéma.

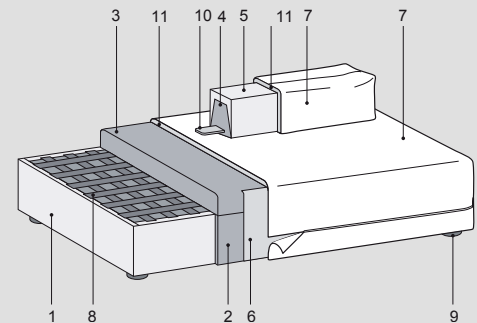
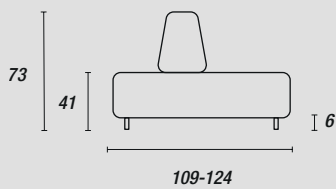

Feet - Pieds::

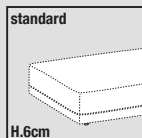

Black (ME09)

Accessories - Accessoires:

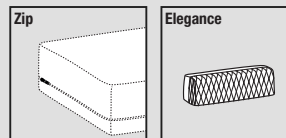

Beige zip (CE01)
Grey zip (CE03)
No zip