

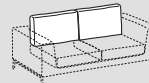

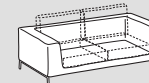





 Seduta - Seat	 Schienali - Backrests	 Struttura - Structure	
Rivestimento Upholstering (9)	Sfoderabile Removable  	Sfoderabile Removable  	Sfoderabile Removable  	
	Non sfoderabile Not removable -	Non sfoderabile Not removable -	Non sfoderabile Not removable -	
Imbottiture Padding (2-4-5-6-7)	 +  D.35kg/m³	 Misto piuma	 +  Tecnoform	 Optional

INFORMAZIONI TECNICHE

Struttura: 1

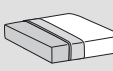
Masselli portanti in abete di vari spessori. Fianchi di tamponamento in pannelli di particelle di legno in classe E1, particolari in pannelli di fibra di legno dura o cellulosa. Struttura rivestita completamente in Tecnoform.

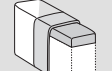
Molleggio: 1-3

Schienale in pannelli di fibra di legno dura o cellulosa. Seduta in nastri elastici di fibra propilenica e lattice.

Note:

Piedini di serie in legno con bordo metallizzato, opzionali piede ad effetto sospeso o, con maggiorazione, basamento in legno. Libreria, piano o tavolino in acciaio verniciato.

TECHNICAL INFORMATION

Structure: 1

Supporting structure in pinewood of various thicknesses. Remaining parts in class E1 particleboard panels, hardboard or cellulose wood-based panels details. Structure completely covered by Tecnoform.

Springing: 1-3

The back is made of hard or cellulose wooden fibre panels. The seat is supported by propylene and latex elastic belts.

Note:

Wooden standard feet with metalized edge, hanging effect foot optional or, with a surcharge, wooden base. Laquered steel bookcase, top or small table.

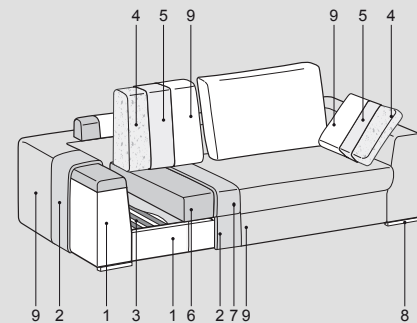
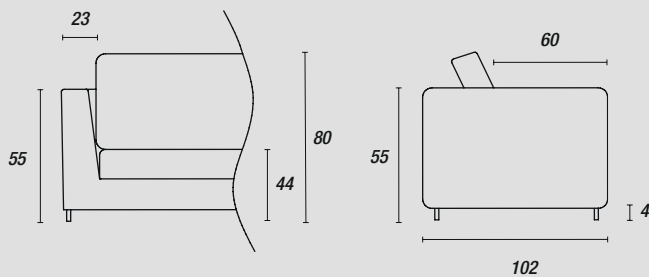

Piedini - Feet:

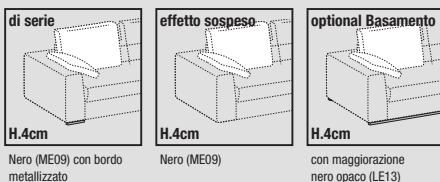











Accessori - Accessories:

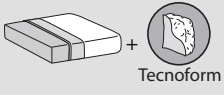

Bijoux next

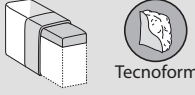

	Seduta - Seat	Schienali - Backrests	Struttura - Structure	
Rivestimento Upholstering (9)	Sfoderabile / Removable  	Sfoderabile / Removable  	Sfoderabile / Removable  	
	Non sfoderabile / Not removable	Non sfoderabile / Not removable	Non sfoderabile / Not removable	
Imbottiture Padding (2-4-5-6-7)	 D.35kg/m³	 Misto piuma	 Tecnoform	 ETHICALLY SOFT MADE Optional

INFORMAZIONI TECNICHE

Struttura: 1

Masselli portanti in abete di vari spessori. Fianchi di tamponamento in pannelli di particelle di legno in classe E1, particolari in pannelli di fibra di legno dura o cellulosa. Struttura rivestita completamente in Tecnoform.

Molleggio: 1-3

Schienale in pannelli di fibra di legno dura o cellulosa. Seduta in nastri elastici di fibra propilenica e lattice.

Note:

Piedini di serie in legno con bordo metallizzato, opzionali piede ad effetto sospeso o, con maggiorazione, basamento in legno. Libreria, piano o tavolino in acciaio verniciato.

TECHNICAL INFORMATION

Structure: 1

Supporting structure in pinewood of various thicknesses. Remaining parts in class E1 particleboard panels, hardboard or cellulose wood-based panels details. Structure completely covered by Tecnoform.

Springing: 1-3

The back is made of hard or cellulose wooden fibre panels. The seat is supported by propylene and latex elastic belts.

Note:

Wooden standard feet with metalized edge, hanging effect foot optional or, with a surcharge, wooden base. Laquered steel bookcase, top or small table.

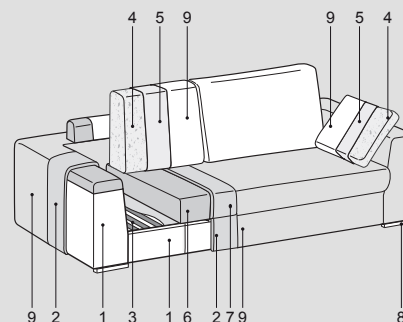
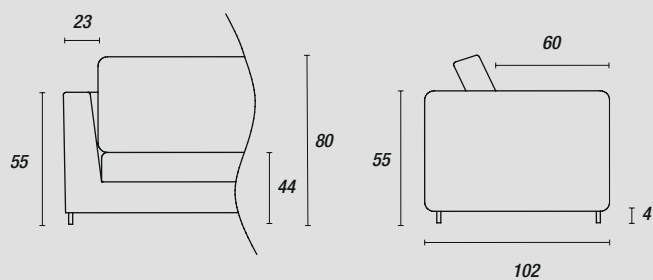

Piedini - Feet:

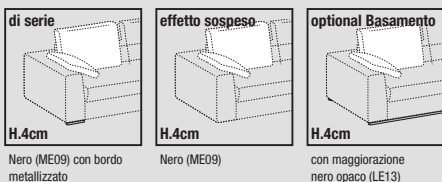

Accessori - Accessories:

