



	Seduta - Seat	Schienali - Backrests	Struttura - Structure	
<b>Rivestimento Upholstering (10)</b>	Sfoderabile / Removable Non sfoderabile / Not removable	Sfoderabile / Removable Non sfoderabile / Not removable	Sfoderabile / Removable Non sfoderabile / Not removable	
<b>Imbottiture Padding (3-4-6-7-8-9)</b>	D.35kg/m³	D.18kg/m³	Pol.espanso	<b>ECOSY</b> ETHICALLY SOFT MADE Optional

## INFORMAZIONI TECNICHE

### Struttura: 1-2

Struttura portante in pannelli di legno listellare multistrato e masselli portanti in abete di vari spessori.

### Molleggio: 1-5

Schienale in pannelli di legno multistrato. Seduta in nastri elastici di fibra propilenica e lattice.

### Note:

Il piedino DUAL sporge di 3cm dal bracciolo, con il piedino DUAL le dimensioni degli elementi di conseguenza variano.

## TECHNICAL INFORMATION

### Structure: 1-2

Structure in solid wood panels, plywood, laminated solid FIR bearing various thicknesses.

### Springing: 1-5

The back is made up of plywood panels. The seat is supported by propylene and latex elastic belts.

### Note:

The DUAL foot protrudes by 3 cm with respect to the armrest. With the DUAL foot, the size of the products varies as a result.

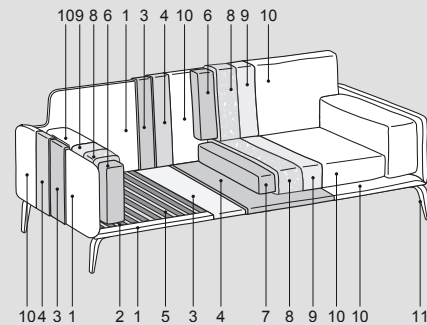
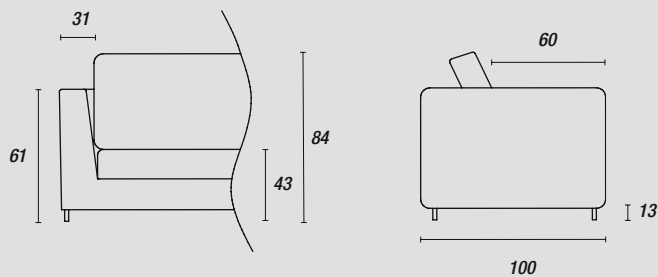

### Piedini - Feet:

#### di serie Bjorg



Nero (ME09)  
Light brown (ME11)  
Antracite (ME01)  
Testa di moro (ME03)

#### optional Bjorg



con maggiorazione  
Cromo lucido (ME04)  
Cromo nero (ME05)

#### optional Dual



con maggiorazione  
Nero (ME09)

#### optional Up



con maggiorazione  
Nero (ME09)  
Light brown (ME11)





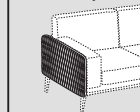

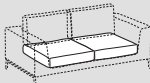
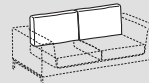
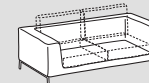

### Accessori - Accessories:

#### Bracciolo trapuntato

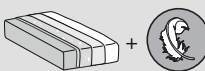

# Kris Mix



	 Seduta - Seat	 Schienali - Backrests	 Struttura - Structure	
<b>Rivestimento Upholstering (10)</b> Sfoderabile Removable			-	
Non sfoderabile Not removable	-	-		
<b>Imbottiture Padding (3-4-6-7-8-9)</b>	 D.35kg/m³	 D.18kg/m³	 Pol.espanso Tecnoform	 Optional

## INFORMAZIONI TECNICHE

### Struttura: 1-2

Struttura portante in pannelli di legno listellare multistrato e masselli portanti in abete di vari spessori.

### Molleggio: 1-5

Schienale in pannelli di legno multistrato.  
Seduta in nastri elastici di fibra propilenica e lattice.

### Note:

Scocca rivestita in pelle Cat. Soft; per articolo imbottito con parti in pelle di altre categorie, aggiungere la maggiorazione indicata.

**Il piedino DUAL sporge di 3cm dal bracciolo, con il piedino DUAL le dimensioni degli elementi di conseguenza variano.**

## TECHNICAL INFORMATION

### Structure: 1-2

Structure in solid wood panels, plywood, laminated solid FIR bearing various thicknesses.

### Springing: 1-5

The back is made up of plywood panels.  
The seat is supported by propylene and latex elastic belts.

### Note:

Base covered with Soft leather; for articles upholstered with leather parts from other categories, consider the indicated surcharge

**The DUAL foot protrudes by 3 cm with respect to the armrest. With the DUAL foot, the size of the products varies as a result.**

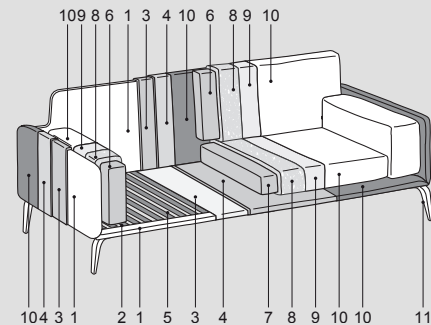
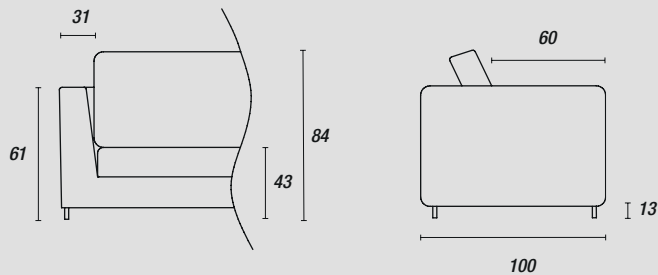

### Piedini - Feet:

#### di serie Bjorg

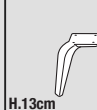

H.13cm  
Nero (ME09)  
Light brown (ME11)  
Antracite (ME01)  
Testa di moro (ME03)

#### optional Bjorg

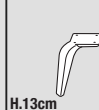

H.13cm  
con maggiorazione  
Cromo lucido (ME04)  
Cromo nero (ME05)

#### optional Dual

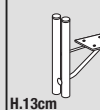

H.13cm  
con maggiorazione  
Nero (ME09)

#### optional Up

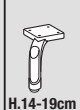

H.14-19cm  
con maggiorazione  
Nero (ME09)  
Light brown (ME11)





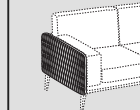





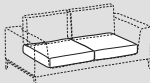
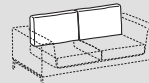
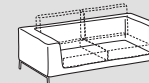



### Accessori - Accessories:

#### Bracciolo trapuntato

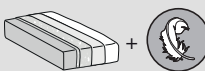

# Kris Low



	 Seduta - Seat	 Schienali - Backrests	 Struttura - Structure	
<b>Rivestimento Upholstering (10)</b>	Sfoderabile Removable   	  		
	Non sfoderabile Not removable -	-	 	
<b>Imbottiture Padding (3-4-6-7-8-9)</b>	 D.35kg/m³	 D.18kg/m³	 Pol.espanso Tecnoform	 Optional

## INFORMAZIONI TECNICHE

### Struttura: 1-2

Struttura portante in pannelli di legno listellare multistrato e masselli portanti in abete di vari spessori.

### Molleggio: 1-5

Schienale in pannelli di legno multistrato.  
Seduta in nastri elastici di fibra propilenica e lattice.

### Note:

Il piedino DUAL sporge di 3cm dal bracciolo, con il piedino DUAL le dimensioni degli elementi di conseguenza variano.

## TECHNICAL INFORMATION

### Structure: 1-2

Structure in solid wood panels, plywood, laminated solid FIR bearing various thicknesses.

### Springing: 1-5

The back is made up of plywood panels.  
The seat is supported by propylene and latex elastic belts.

### Note:

The DUAL foot protrudes by 3 cm with respect to the armrest. With the DUAL foot, the size of the products varies as a result.

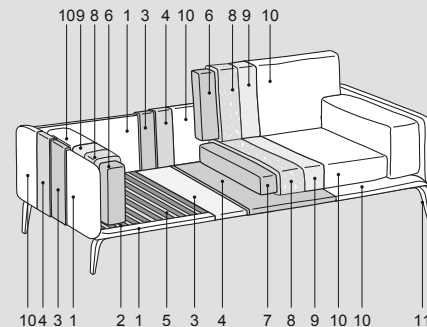
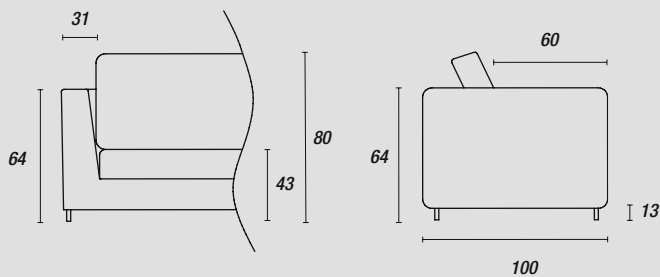

### Piedini - Feet:

#### di serie Bjorg



H.13cm  
Nero (ME09)  
Light brown (ME11)  
Antracite (ME01)  
Testa di moro (ME03)

#### optional Bjorg



H.13cm  
con maggiorazione  
Cromo lucido (ME04)  
Cromo nero (ME05)

#### optional Dual



H.13cm  
con maggiorazione  
Nero (ME09)

#### optional Up

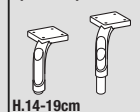

H.14-19cm  
con maggiorazione  
Nero (ME09)  
Light brown (ME11)





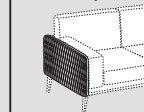

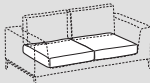
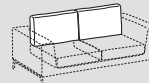
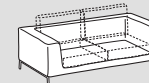

### Accessori - Accessories:

#### Bracciolo trapuntato

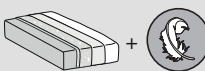

# Kris Mix Low



	 Seduta - Seat	 Schienali - Backrests	 Struttura - Structure	
<b>Rivestimento Upholstering (10)</b>	Sfoderabile Removable 	Sfoderabile Removable 	-	
	Non sfoderabile Not removable -	Non sfoderabile Not removable -		
<b>Imbottiture Padding (3-4-6-7-8-9)</b>	 D.35kg/m³	 D.18kg/m³	 Pol.espanso	 Optional

## INFORMAZIONI TECNICHE

### Struttura: 1-2

Struttura portante in pannelli di legno listellare multistrato e masselli portanti in abete di vari spessori.

### Molleggio: 1-5

Schienale in pannelli di legno multistrato. Seduta in nastri elastici di fibra propilenica e lattice.

### Note:

Scocca rivestita in pelle Cat. Soft; per articolo imbottito con parti in pelle di altre categorie, aggiungere la maggiorazione indicata. Bordo di serie tono su tono, se in contrasto specificare il colore.

Il piedino DUAL sporge di 3cm dal bracciolo, con il piedino DUAL le dimensioni degli elementi di conseguenza variano.

## TECHNICAL INFORMATION

### Structure: 1-2

Structure in solid wood panels, plywood, laminated solid FIR bearing various thicknesses.

### Springing: 1-5

The back is made up of plywood panels. The seat is supported by propylene and latex elastic belts.

### Note:

Base covered with Soft leather; for articles upholstered with leather parts from other categories, consider the indicated surcharge. Tone on tone edge as a standard, if contrasting, specify the color.

The DUAL foot protrudes by 3 cm with respect to the armrest. With the DUAL foot, the size of the products varies as a result.

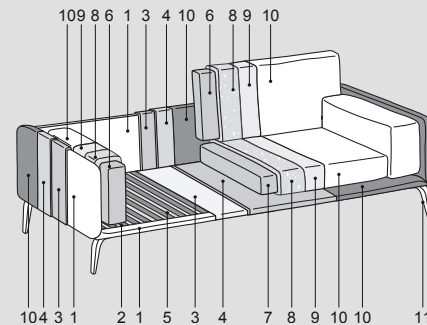
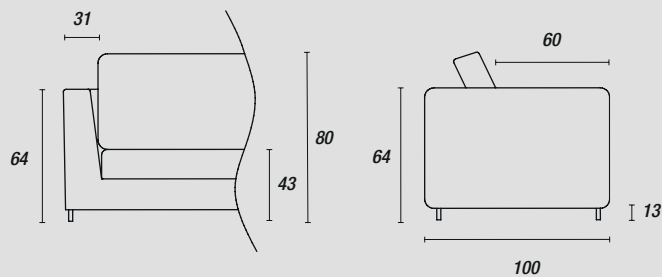

### Piedini - Feet:

#### di serie Bjorg



Nero (ME09)  
Light brown (ME11)  
Antracite (ME01)  
Testa di moro (ME03)

#### optional Bjorg



con maggiorazione  
Cromo lucido (ME04)  
Cromo nero (ME05)

#### optional Dual



con maggiorazione  
Nero (ME09)

#### optional Up



con maggiorazione  
Nero (ME09)  
Light brown (ME11)

### Accessori - Accessories:

#### Bracciolo trapuntato

