

Lennox



	Seduta - Seat	Schienali - Backrests	Struttura - Structure	
Rivestimento Upholstering (10)	Sfoderabile / Removable Non sfoderabile / Not removable	Sfoderabile / Removable Non sfoderabile / Not removable	Sfoderabile / Removable Non sfoderabile / Not removable	
Imbottiture Padding (3-4-5-6-7-8-9)	D.35/40kg/m³	D.21kg/m³	Tecnoform	ECOSY ETHICALLY SOFT MADE Optional

INFORMAZIONI TECNICHE

Struttura: 1

Struttura portante in pannelli di legno listellare multistrato e masselli portanti in abete di vari spessori sostenuta da telaio in acciaio sagomato.

Molleggio: 1-2

Schienale in pannello in multistrati di legno o di particelle di legno in classe E1. Seduta in nastri elastici di fibra propilenica e lattice.

TECHNICAL INFORMATION

Structure: 1

Structure in solid wood panels, plywood, laminated solid FIR bearing various thicknesses supported by shaped steel frame.

Springing: 1-2

The back is made of multilayered wood or class E1 wood particleboard panels. The seat is supported by propylene and latex elastic belts.

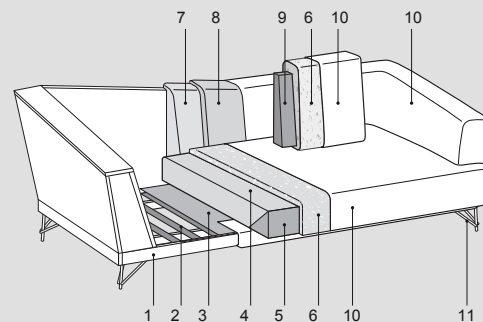
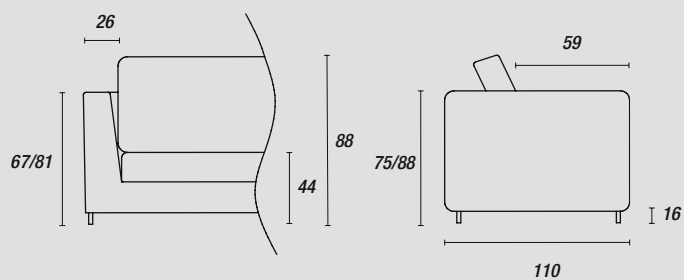

Piedini - Feet:

di serie Lennox



H.16cm

Nero (ME09)

optional Sled











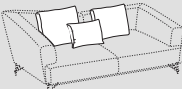





H.16cm

con maggiorazione
Nero (ME09)
Cromo lucido (ME04)

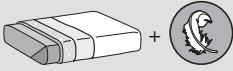
Lennox soft



	 Seduta - Seat	 Set cuscini - Cushions set	 Struttura - Structure	
Rivestimento Upholstering (10)	Sfoderabile Removable  	 		
	Non sfoderabile Not removable 		 	
Imbottiture Padding (3-4-5-6-7-8-9)	 D.35/40kg/m³	 Misto piuma	 Tecnoform	 Optional

INFORMAZIONI TECNICHE

Struttura: 1

Struttura portante in pannelli di legno listellare multistrato e masselli portanti in abete di vari spessori sostenuta da telaio in acciaio sagomato.

Molleggio: 1-2

Schienale in pannello in multistrati di legno o di particelle di legno in classe E1. Seduta in nastri elastici di fibra propilenica e lattice.

TECHNICAL INFORMATION

Structure: 1

Structure in solid wood panels, plywood, laminated solid FIR bearing various thicknesses supported by shaped steel frame.

Springing: 1-2

The back is made of multilayered wood or class E1 wood particleboard panels. The seat is supported by propylene and latex elastic belts.

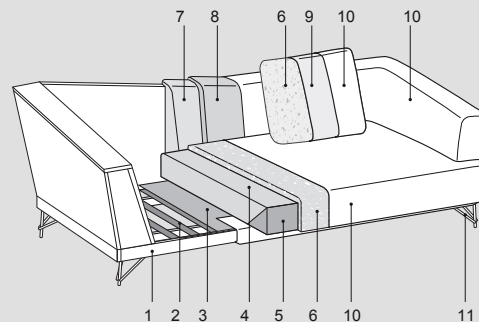
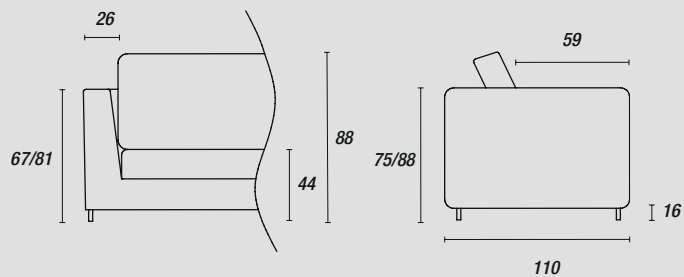

Piedini - Feet:

di serie Lennox



H.16cm

Nero (ME09)

optional Sled



H.16cm

con maggiorazione
Nero (ME09)
Cromo lucido (ME04)