

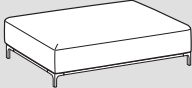











Sanders air

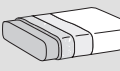

	 Basi - Bases	 Schienali - Backrests		
Rivestimento Upholstering (10)	Sfoderabile Removable 	  		
	Non sfoderabile Not removable  	-		
Imbottiture Padding (3-4-5-6-7-8-9)	  D.35kg/m ³	  D.75/25kg/m ³ +zavorra		 Optional

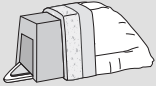
INFORMAZIONI TECNICHE

Struttura: 1

Masselli portanti in abete di vari spessori. Fianchi di tamponamento in pannelli di particelle di legno in classe E1, particolari in pannelli di fibra di legno dura.

Molleggio: 2

Seduta in nastri elastici di fibra propilenica e lattice.

Note:

* Per versioni in pelle contattare l'ufficio vendite.

L'ordine di ogni composizione deve sempre essere corredato da un disegno in pianta.

TECHNICAL INFORMATION

Structure: 1

Supporting structure in pinewood of various thicknesses. Remaining parts in Class E1 wood particleboard panels, details in hard wood-based panels.

Springing: 2

The seat is supported by propylene and latex elastic belts.

Note:

* For the leather versions please contact the sales department.

For orders of compositions a sketch is requested.

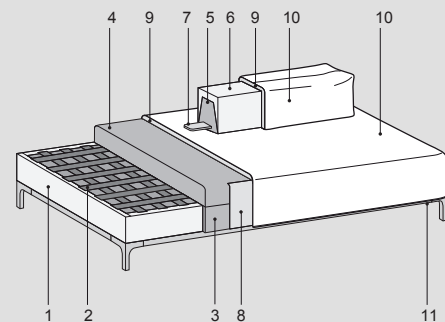
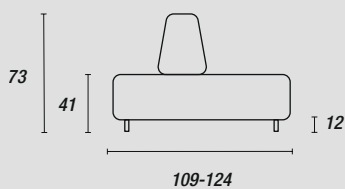

Piedini - Feet:



Nero (ME09)
Light brown (ME11)
Antracite (ME01)
Testa di moro (ME03)

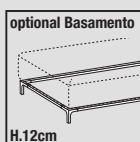

con maggiorazione
Cromo lucido (ME04)

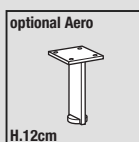





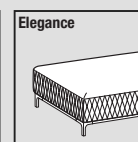
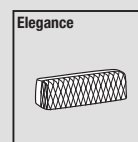



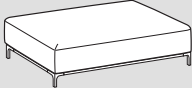

Nero (ME09)
Light brown (ME11)

Accessori - Accessories:

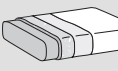

Sanders air mix



	 Basi - Bases	 Schienali - Backrests		
Rivestimento Upholstering (10)	Sfoderabile Removable -	 		
	Non sfoderabile Not removable  	-		
Imbottiture Padding (3-4-5-6-7-8)	  D.35kg/m³	  D.75/25kg/m³+zavorra		 Optional

INFORMAZIONI TECNICHE

Struttura: 1

Masselli portanti in abete di vari spessori. Fianchi di tamponamento in pannelli di particelle di legno in classe E1, particolari in pannelli di fibra di legno dura.

Molleggio: 2

Seduta in nastri elastici di fibra propilenica e lattice.

Note:

Base rivestita in tessuto e parzialmente rivestita in pelle Cat. Soft; per articolo imbottito con parti in pelle di altre categorie, aggiungere la maggiorazione indicata.

L'ordine di ogni composizione deve sempre essere corredato da un disegno in pianta.

TECHNICAL INFORMATION

Structure: 1

Supporting structure in pinewood of various thicknesses. Remaining parts in Class E1 wood particleboard panels, details in hard wood-based panels.

Springing: 2

The seat is supported by propylene and latex elastic belts.

Note:

Base upholstered in fabric and partially upholstered in leather Soft category; for the upholstery in other leather categories, please add the indicated increase in price. For orders of compositions a sketch is requested.

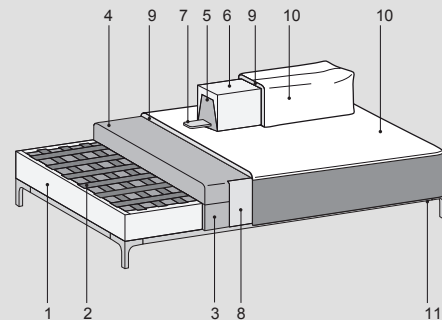
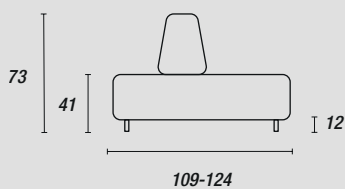

Piedini - Feet:



Nero (ME09)
Light brown (ME11)
Antracite (ME01)
Testa di moro (ME03)



con maggiorazione
Cromo lucido (ME04)

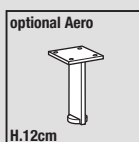

Nero (ME09)
Light brown (ME11)

Accessori - Accessories:

