

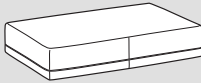











Sanders

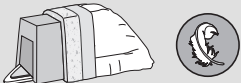

	 Basi - Bases	 Schienali - Backrests	 Bracciolo - Armrest	
Rivestimento Upholstering (7)	Sfoderabile Removable 	Sfoderabile Removable   	Sfoderabile Removable 	
	Non sfoderabile Not removable 	-	Non sfoderabile Not removable 	
Imbottiture Padding (2-3-4-5-6-10-11)	 D.35kg/m ³	 D.75/25kg/m ² +zavorra	 Pol.espanso	 Optional

INFORMAZIONI TECNICHE

Struttura: 1

Masselli portanti in abete di vari spessori. Fianchi di tamponamento in pannelli di particelle di legno in classe E1, particolari in pannelli di fibra di legno dura.

Molleggio: 8

Seduta in nastri elastici di fibra propilenica e lattice.

Note:

L'ordine di ogni composizione deve sempre essere corredato da un disegno in pianta.

TECHNICAL INFORMATION

Structure: 1

Supporting structure in pinewood of various thicknesses. Remaining parts in Class E1 wood particleboard panels, details in hard wood-based panels.

Springing: 8

The seat is supported by propylene and latex elastic belts.

Note:

For orders of compositions a sketch is requested.

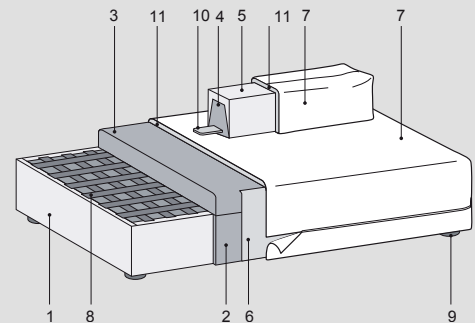
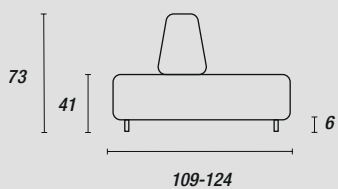

Piedini - Feet:

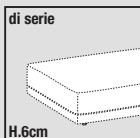

Nero (ME09)

Accessori - Accessories:

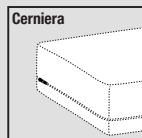

Cerniera beige (CE01)
Cerniera grigio (CE03)
Senza cerniera

