

# Althon high



	Seduta - Seat	Schienali - Backrests	Struttura - Structure	
<b>Rivestimento Upholstering (12)</b>	Sfoderabile Removable Non sfoderabile Not removable	Sfoderabile Removable Non sfoderabile Not removable	Sfoderabile Removable Non sfoderabile Not removable	
<b>Imbottiture Padding (5-6-7-8-9-10-11)</b>	D.35/50kg/m <sup>3</sup> memory foam	D.25-30kg/m <sup>3</sup>	Pol.espanso	<b>ECOSY</b> ETHICALLY SOFT MADE Optional

## INFORMAZIONI TECNICHE

### Struttura: 1-3

Struttura base in pannelli di legno multistrati in classe E1. Masselli portanti in legno di abete. Elementi strutturali in pannelli di legno multistrati in classe E1 e pannelli di particelle di legno in classe E1, tamponamenti in faesite.

### Molleggio: 1-4

Schienale in pannello di faesite.

Seduta in nastri elastici di fibra propilenica e lattice incrociati e meccanicamente pretensionati.

### Note:

Braccioli ALTHON disponibili in rigenerato di cuoio, la cucitura sul bracciolo e' sempre in tinta, nella parte arrotondata sono presenti dei tappi di chiusura in finitura metallo inox (2).

Nella versione in tessuto per l'inserto (14) utilizzare solo il tessuto Tallin. Nella versione in pelle inserto non disponibile.

## TECHNICAL INFORMATION

### Structure: 1-3

Frame structure in plywood panels in class E1. Solid fir wood. Structural elements in multilayer wood panels in class E1 and panels of wood particles in class E1, infills in faesite.

### Springing: 1-4

The back is made of hardboard panels.

Seat with pre-tensioned crossed propylene fibre and latex elastic webbing.

### Note:

ALTHON arm available in recycled bonded leather, the stitching on the arm is in the same shade as the leather, in the rounded part there are closing plugs in stainless steel finish (2).

In the fabric version use only Tallin fabric for the insert (14). In the leather version the insert it is not available.

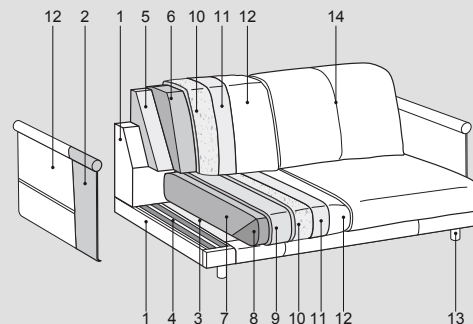
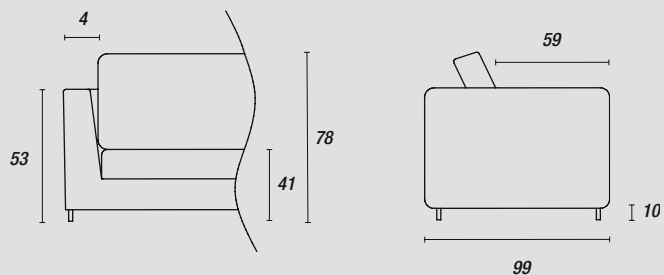

### Piedini - Feet:

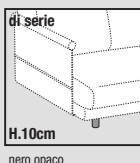



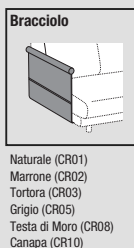





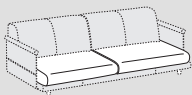
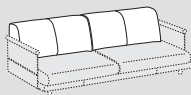







### Accessori - Accessories:

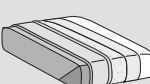

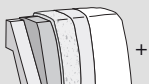
# Althon low



	 Seduta - Seat	 Schienali - Backrests	 Struttura - Structure	
<b>Rivestimento Upholstering (12)</b>	Sfoderabile Removable   	 	 	
Non sfoderabile Not removable	—			
<b>Imbottiture Padding (5-6-7-8-9-10-11)</b>	 D.35/50kg/m <sup>3</sup>  memory foam 	 D.25-30kg/m <sup>3</sup> 	 Pol.espanso	 Optional

## INFORMAZIONI TECNICHE

### Struttura: 1-2-3

Struttura base in pannelli di legno multistrati in classe E1. Masselli portanti in legno di abete. Elementi strutturali in pannelli di legno multistrati in classe E1 e pannelli di particelle di legno in classe E1, tamponamenti in faesite.

### Molleggio: 1-4

Schienale in pannello di faesite.

Seduta in nastri elastici di fibra propilenica e lattice incrociati e meccanicamente pretensionati.

### Note:

Braccioli ALTHON disponibili in rigenerato di cuoio, la cucitura sul bracciolo e' sempre in tinta, nella parte arrotondata sono presenti dei tappi di chiusura in finitura metallo inox (2).

Nella versione in tessuto per l'inserto (14) utilizzare solo il tessuto Tallin. Nella versione in pelle inserto non disponibile.

## TECHNICAL INFORMATION

### Structure: 1-2-3

Frame structure in plywood panels in class E1. Solid fir wood. Structural elements in multilayer wood panels in class E1 and panels of wood particles in class E1, infills in faesite.

### Springing: 1-4

The back is made of hardboard panels.

Seat with pre-tensioned crossed propylene fibre and latex elastic webbing.

### Note:

ALTHON arm available in recycled bonded leather, the stitching on the arm is in the same shade as the leather, in the rounded part there are closing plugs in stainless steel finish (2).

In the fabric version use only Tallin fabric for the insert (14). In the leather version the insert it is not available.

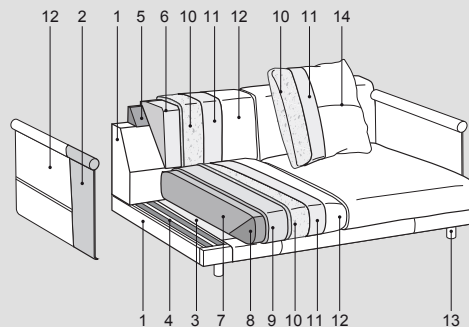
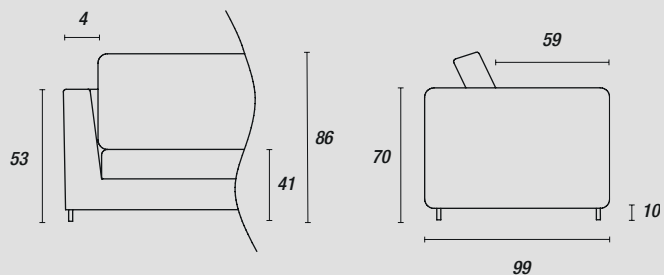

### Piedini - Feet:

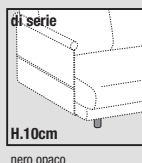

### Accessori - Accessories:

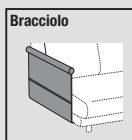

Naturale (CR01)  
Marrone (CR02)  
Tortora (CR03)  
Grigio (CR05)  
Testa di Moro (CR08)  
Canapa (CR10)