

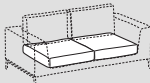

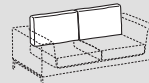

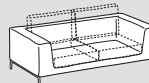







Nevyll high

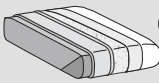

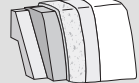
	 Sitzkissen - <i>Seduta</i>	 Rückenkissen - <i>Schienali</i>	 Gestell - <i>Struttura</i>	
Bezug: Rivestimento (12)	abziehbar <i>Sfoderabile</i>  			
	nicht abziehbar <i>Non sfoderabile</i> —			
Polsterungen Imbottiture (2-3-5-6-7-8-9-10-11)	   D.35/50kg/m ³	  D.25/30kg/m ³	  Polyurethanschaumstoff	 optional

TECHNISCHE BESCHREIBUNG

Gestell: 1-2

Tragende Massivholzteile aus Tanne und Buche in verschieden dicken. Seitenteile aus Spanplattier tier E1, einzelelemente aus hartholzfaserplatten.

Federung: 4

Rückenlehne aus harten Holzfasern oder Zellulose.
Sitz in gekreuzten und mechanisch vorgespannten elastischen Bändern aus Propylenfaser und Latex.

Hinweis

Für Stoffversion kann die Band (14) nur in Miami Stoff sein. Lederversion hat keine Band.

INFORMAZIONI TECNICHE

Struttura: 1-2

Masselli portanti in legno di abete e faggio di vari spessori. Fianchi di tamponamento in pannelli di particelle di legno in classe E1, particolari in pannelli di fibra di legno dura o cellulosa.

Molleggio: 4

Schienale in pannelli di fibra di legno dura o cellulosa.
Seduta in nastri elastici di fibra propilenica e lattice incrociati e meccanicamente pretensionati.

Note:

Nella versione con rivestimento in tessuto per l'inserto (14) utilizzare solo il tessuto Miami.
Nella versione con rivestimento in pelle inserto non disponibile.

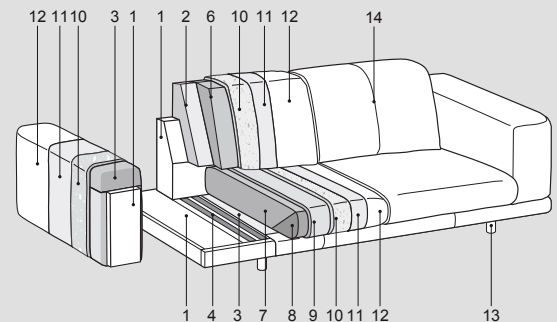
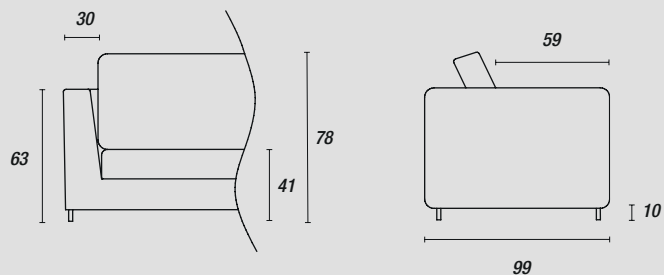

Füße - Piedini:



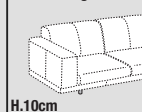











serienmäßig

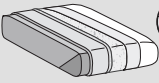

H.10cm
Schwarzes Metall (ME09)

Nevyll low



	Sitzkissen - Seduta	Kissen - Cuscini	Gestell - Struttura	
Bezug: Rivestimento (12)	abziehbar <i>Sfoderabile</i>	abziehbar <i>Sfoderabile</i>	abziehbar <i>Sfoderabile</i>	
	 	 		
	nicht abziehbar <i>Non sfoderabile</i>	nicht abziehbar <i>Non sfoderabile</i>	nicht abziehbar <i>Non sfoderabile</i>	
	—	—		
Polsterungen Imbottiture (2-3-5-6-7-8-9-10-11)	   memory foam D.35/50kg/m ³	  D.25/30kg/m ³	 +  Polyurethanschaumstoff	 ETHICALLY SOFT MADE optional

TECHNISCHE BESCHREIBUNG

Gestell: 1-2

Tragende Massivholzteile aus Tanne und Buche in verschiedenen dicken. Seitenteile aus Spanplatten tier E1, einzelnelemente aus hartholzfaserplatten.

Federung: 4

Rückenlehne aus harten Holzfasern oder Zellulose.
Sitz in gekreuzten und mechanisch vorgespannten elastischen Bändern aus Propylenfaser und Latex.

Hinweis

Für Stoffversion kann die Band (14) nur in Miami Stoff sein. Lederversion hat keine Band.

INFORMAZIONI TECNICHE

Struttura: 1-2

Masselli portanti in legno di abete e faggio di vari spessori. Fianchi di tamponamento in pannelli di particelle di legno in classe E1, particolari in pannelli di fibra di legno dura o cellulosa.

Molleggio: 4

Schienale in pannelli di fibra di legno dura o cellulosa.
Seduta in nastri elastici di fibra propilenica e lattice incrociati e meccanicamente pretensionati.

Note:

Nella versione con rivestimento in tessuto per l'inserto (14) utilizzare solo il tessuto Miami.
Nella versione con rivestimento in pelle inserto non disponibile.

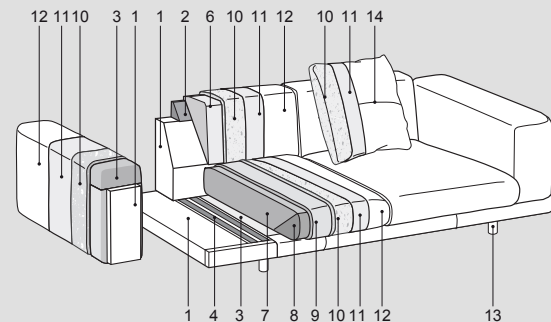
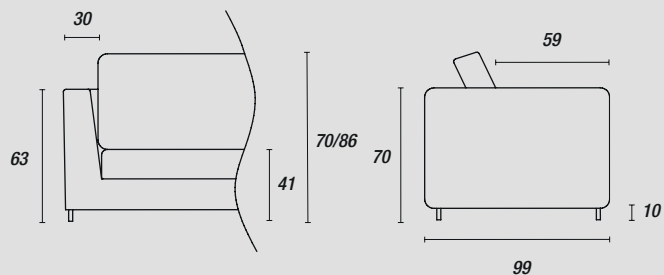

FüÙe - Piedini:

serienmäßig

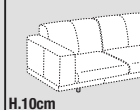

Schwarzes Metall (ME09)