













# Althon high

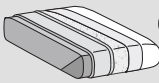

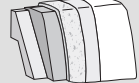
	Sitzkissen - <i>Seduta</i>	Rückenkissen - <i>Schienali</i>	Gestell - <i>Struttura</i>	
<b>Bezug:</b> <b>Rivestimento</b> (12)	abziehbar <i>Sfoderabile</i>			
	 			
	nicht abziehbar <i>Non sfoderabile</i>			
	—			
<b>Polsterungen</b> <b>Imbottiture</b> (5-6-7-8-9-10-11)	   D.35/50kg/m <sup>3</sup>	  D.25-30kg/m <sup>3</sup>	 Polyurethanschaumstoff	 optional

## TECHNISCHE BESCHREIBUNG

### Gestell: 1-3

Tragende Massivholzteile aus Tanne und Buche in verschieden dicken. Seitenteile aus Spanplattier tier E1, einzelelemente aus hartholzfaserplatten.

### Federung: 1-4

Rückenlehne aus harten Holzfasern oder Zellulose.  
Sitzfläche mit elastischen Gurten aus Propylenfaser und Latex.

### Hinweis

Armlehne Althon in regeneriertem Leder Natur (CR01), Braun (CR02), Taubengrau (CR03), Grau (CR05), Dunkelbraun (CR08) und Hanf (CR10) erhältlich; Nähte der Armlehnen Ton in Ton. Der abgerundeten Teil hat Stöpsel aus Inox-metall (2).

Für Stoffversion kann die Band (14) nur in Miami Stoff sein. Lederversion hat keine Band.

## INFORMAZIONI TECNICHE

### Struttura: 1-3

Masselli portanti in legno di abete e faggio di vari spessori. Fianchi di tamponamento in pannelli di particelle di legno in classe E1, particolari in pannelli di fibra di legno dura o cellulosa.

### Molleggio: 1-4

Schienale in pannelli di fibra di legno dura o cellulosa.  
Seduta in nastri elastici di fibra propilenica e lattice.

### Note:

Braccioli ALTHON disponibili in rigenerato di cuoio nei colori naturale (CR01), marrone (CR02), tortora (CR03), grigio (CR05), testa di moro (CR08) e canapa (CR10); la cucitura sul bracciolo e' sempre in tinta, nella parte arrotondata sono presenti dei tappi di chiusura in finitura metallo inox (2).

Nella versione in tessuto per l'insero (14) utilizzare solo il tessuto Miami. Nella versione in pelle inserto non disponibile.

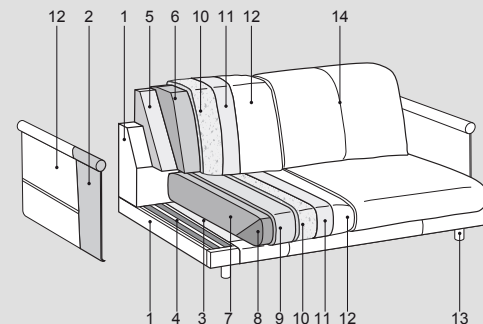
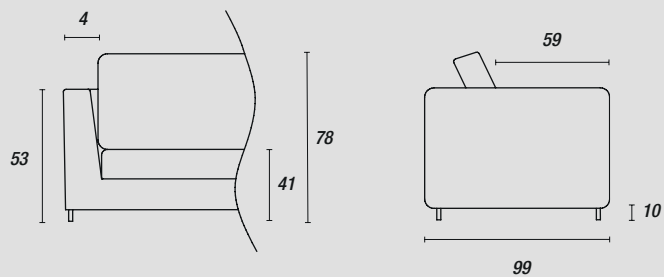

### Füße - Piedini:

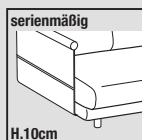

Schwarzes Metall (ME09)



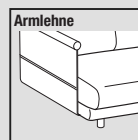







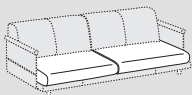
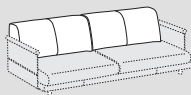



### Zubehör - Accessori:

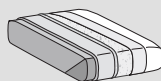

Natur (CR01)  
Braun (CR02)  
Taubengrau (CR03)  
Grau (CR05)  
Dunkelbraun (CR08)  
Hanf (CR10)

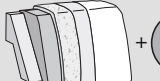
# Althon low



	 Sitzkissen - <i>Seduta</i>	 Rückenkissen - <i>Schienali</i>	 Gestell - <i>Struttura</i>	
<b>Bezug: Rivestimento (12)</b>	abziehbar <i>Sfoderabile</i>	 		
	nicht abziehbar <i>Non sfoderabile</i>	—		
<b>Polsterungen Imbottiture (5-6-7-8-9-10-11)</b>	   D.35/50kg/m <sup>3</sup>	  D.25-30kg/m <sup>3</sup>	 Polyurethanschaumstoff	 optional

## TECHNISCHE BESCHREIBUNG

### Gestell: 1-2-3

Tragende Massivholzteile aus Tanne und Buche in verschieden dicken. Seitenteile aus Spanplatter tier E1, einzelelemente aus hartholzfaserplatten.

### Federung: 1-4

Rückenlehne aus harten Holzfasern oder Zellulose. Sitzfläche mit elastischen Gurten aus Propylenfaser und Latex.

### Hinweis

Armlehne Althon in regeneriertem Leder Natur (CR01), Braun (CR02), Taubengrau (CR03), Grau (CR05), Dunkelbraun (CR08) und Hanf (CR10) erhältlich; Nähte der Armlehnen Ton in Ton. Der abgerundeten Teil hat Stöpsel aus Inox-metall (2).

Für Stoffversion kann die Band (14) nur in Miami Stoff sein. Lederversion hat keine Band.

## INFORMAZIONI TECNICHE

### Struttura: 1-2-3

Masselli portanti in legno di abete e faggio di vari spessori. Fianchi di tamponamento in pannelli di particelle di legno in classe E1, particolari in pannelli di fibra di legno dura o cellulosa.

### Molleggio: 1-4

Schienale in pannelli di fibra di legno dura o cellulosa. Seduta in nastri elastici di fibra propilenica e lattice.

### Note:

Braccioli ALTHON disponibili in rigenerato di cuoio nei colori naturale (CR01), marrone (CR02), tortora (CR03), grigio (CR05), testa di moro (CR08) e canapa (CR10); la cucitura sul bracciolo e' sempre in tinta, nella parte arrotondata sono presenti dei tappi di chiusura in finitura metallo inox (2).

Nella versione in tessuto per l'insero (14) utilizzare solo il tessuto Miami. Nella versione in pelle inserto non disponibile.

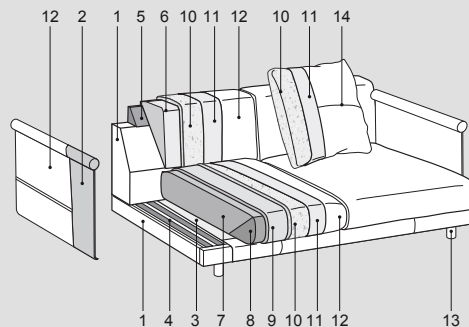
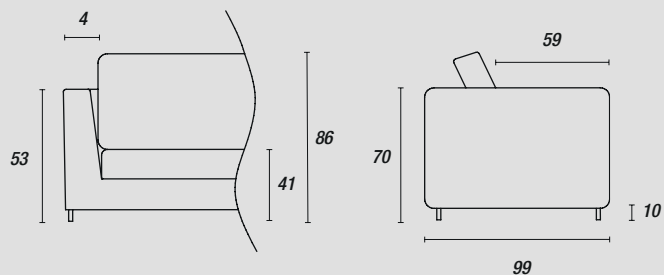

### Füße - Piedini:

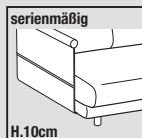

### Zubehör - Accessori:

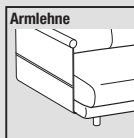

Natur (CR01)  
Braun (CR02)  
Taubengrau (CR03)  
Grau (CR05)  
Dunkelbraun (CR08)  
Hanf (CR10)