

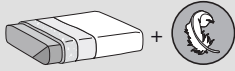



Kailua



	Sitzkissen - <i>Seduta</i>	Rückenkissen - <i>Schienali</i>	Gestell - <i>Struttura</i>	
Bezug: Rivestimento (8)	abziehbar <i>Sfoderabile</i>	abziehbar <i>Sfoderabile</i>	abziehbar <i>Sfoderabile</i>	
	nicht abziehbar <i>Non sfoderabile</i>	nicht abziehbar <i>Non sfoderabile</i>	nicht abziehbar <i>Non sfoderabile</i>	
Polsterungen Imbottiture (2-3-4-5-6-7)	 D.50/35kg/m³	 Daunen und Polyesterfaser gemischt	 Polyurethanschaumstoff mit Vlies	 optional

TECHNISCHE BESCHREIBUNG

Gestell: 1

Tragen der Struktur, Zarge am metall und Holzplatte mit holzpartikel klass E1 beschichtet am gekuppelt.

Federung: 1

Rückenlehnen-platten mit Holzpartikel (klass) E1
Sitzfläche-platten aus mehrschichtigen Holz (klass) E1

INFORMAZIONI TECNICHE

Struttura: 1

Struttura portante telaio in metallo e pannelli di legno multistrato con pannelli di particelle di legno in classe E1 rivestiti in accoppiato.

Molleggio: 1

Pannelli schienale in particelle di legno in classe E1.
Pannello seduta in legno multistrato classe E1.

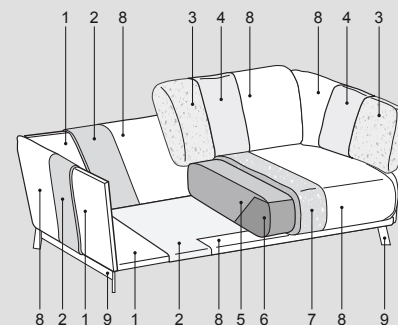
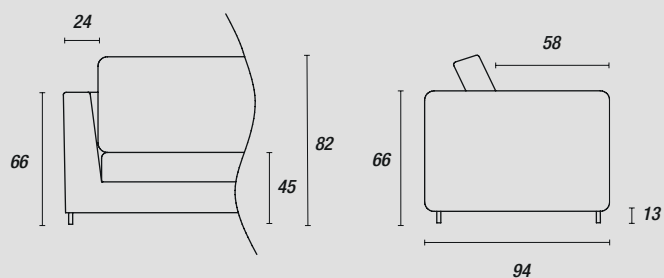

Füße - Piedini:

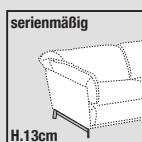



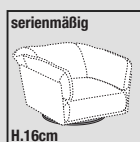





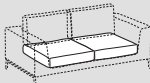
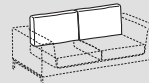
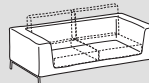

H.13cm
Anthrakit (ME01)
Light brown (ME11)



H.16cm
Schwarzes Metall (ME09)

Kailua mix



	 Sitzkissen - <i>Seduta</i>	 Rückenkissen - <i>Schienali</i>	 Gestell - <i>Struttura</i>	
Bezug: Rivestimento (8)	abziehbar <i>Sfoderabile</i> 	Rückenkissen - <i>Schienali</i> 		
	nicht abziehbar <i>Non sfoderabile</i> 			
Polsterungen Imbottiture (2-3-4-5-6-7)	 D.50/35kg/m ³	 Daunen und Polyesterfaser gemischt	 Polyurethanschaumstoff mit Vlies	 optional

TECHNISCHE BESCHREIBUNG

Gestell: 1

Tragen der Struktur, Zarge am metall und Holzplatte mit holzpartikel klass E1 beschichtet am gekuppelt.

Federung: 1

Rückenlehnen-platten mit Holzpartikel (klass) E1
Sitzfläche-platten aus mehrschichtigen Holz (klass) E1

Hinweis

Korpus in Leder Kat. Soft; für Polsterartikel mit Lederteilen anderer Kategorien den angegebenen Zuschlag hinzufügen.

INFORMAZIONI TECNICHE

Struttura: 1

Struttura portante telaio in metallo e pannelli di legno multistrato con pannelli di particelle di legno in classe E1 rivestiti in accoppiato.

Molleggio: 1

Pannelli schienale in particelle di legno in classe E1.
Pannello seduta in legno multistrato classe E1.

Note:

Scocca rivestita in pelle Cat. Soft; per articolo imbottito con parti in pelle di altre categorie, aggiungere la maggiorazione indicata.

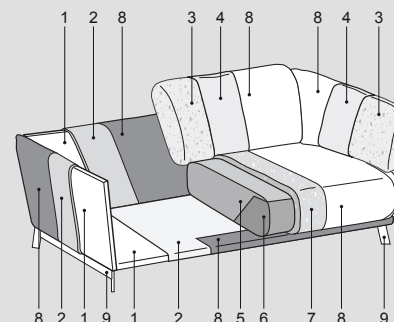
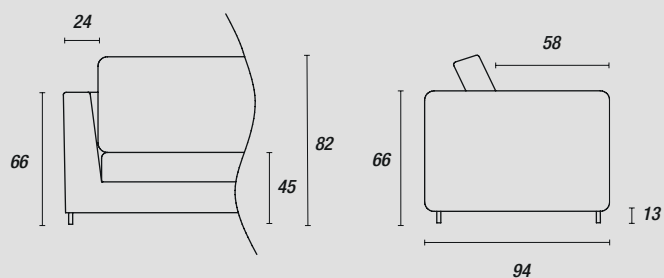

Füße - Piedini:

serienmäßig

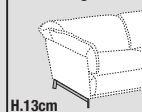

Anthrazit (ME01)
Light brown (ME11)

serienmäßig

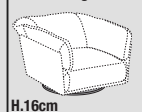

Schwarzes Metall (ME09)