













# Nevyll high

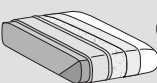

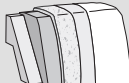
	Seat - Assise	Backrests - Dossiers	Structure - Structure	
<b>Upholstering</b> <i>Revetement</i> (12)	Removable <i>Déhoussable</i>	 		
	Not removable <i>Non déhoussable</i>	—		
<b>Padding</b> <i>Rembourrages</i> (2-3-5-6-7-8-9-10-11)	   D.35/50kg/m <sup>3</sup>	 +  D.25/30kg/m <sup>3</sup>	 +  Polyurethane foam	 ETHICALLY SOFT MADE optional

## TECHNICAL INFORMATION

### Structure: 1-2

Supporting structure in various thickness spruce and beech. Sides and partition in class E1 particleboard panels, details in hardboard panels or cellulose panels.

### Springing: 4

The back is made of hard or cellulose wooden fibre panels.  
Seat with pre-tensioned crossed propylene fibre and latex elastic webbing.

### Note:

In the fabric version use only Miami fabric for the insert (14). In the leather version the insert it is not available.

## INFORMATIONS TECHNIQUES

### Structure: 1-2

Parties de soutien en bois de sapin et étre de différentes épaisseurs. Cotes latéral en panneaux de particules de bois en classe E1, particuliers en panneaux de fibre de bois dure ou cellulose.

### Suspension: 4

Dossier en panneaux de fibre de bois dure ou cellulose.  
Assise en rubans élastique de fibre propylène et latex croisés et mécaniquement pré-tensionnés.

### Note:

Dans la version en tissu pour l'insert (14) utiliser uniquement le tissu Miami. Dans la version en cuir l'insert ce n'est pas disponible.

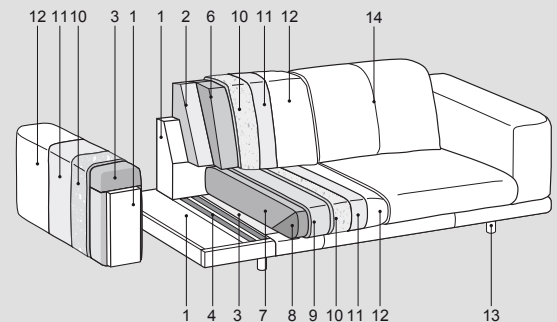
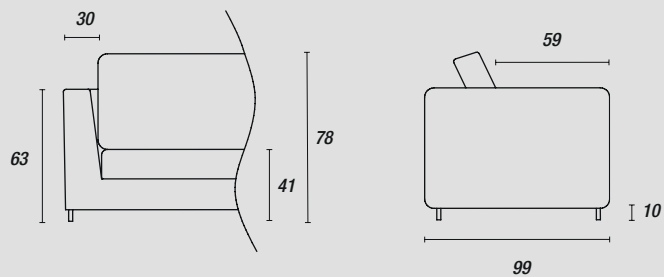

### Feet - Pieds::

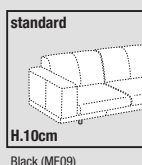

# Nevyll low



	Seat - Assise	Cushions - Coussins	Structure - Structure	
<b>Upholstering</b> <i>Revetement</i> (12)	Removable <i>Déhoussable</i>			
	Not removable <i>Non déhoussable</i>	—	—	
<b>Padding</b> <i>Rembourrages</i> (2-3-5-6-7-8-9-10-11)	 D.35/50kg/m <sup>3</sup>	 D.25/30kg/m <sup>3</sup>	 Polyurethane foam	 ETHICALLY SOFT MADE optional

## TECHNICAL INFORMATION

### Structure: 1-2

Supporting structure in various thickness spruce and beech. Sides and partition in class E1 particleboard panels, details in hardboard panels or cellulose panels.

### Springing: 4

The back is made of hard or cellulose wooden fibre panels.  
Seat with pre-tensioned crossed propylene fibre and latex elastic webbing.

### Note:

In the fabric version use only Miami fabric for the insert (14). In the leather version the insert it is not available.

## INFORMATIONS TECHNIQUES

### Structure: 1-2

Parties de soutien en bois de sapin et étre de différentes épaisseurs. Cotes latéral en panneaux de particules de bois en classe E1, particuliers en panneaux de fibre de bois dure ou cellulose.

### Suspension: 4

Dossier en panneaux de fibre de bois dure ou cellulose.  
Assise en rubans élastique de fibre propylène et latex croisés et mécaniquement pré-tensionnés.

### Note:

Dans la version en tissu pour l'insert (14) utiliser uniquement le tissu Miami. Dans la version en cuir l'insert ce n'est pas disponible.

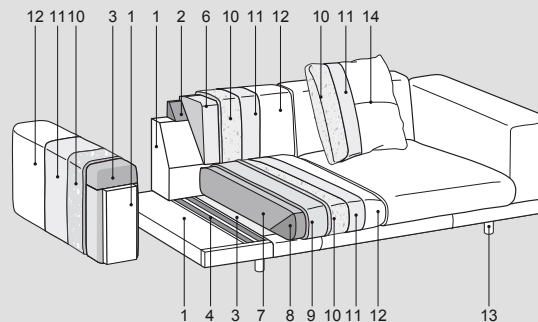
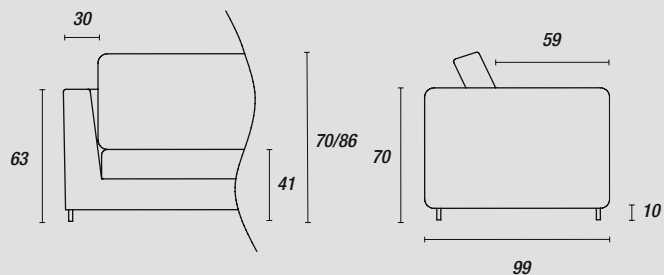

### Feet - Pieds::

standard

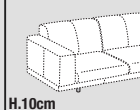

Black (ME09)