

Althon high



	Seduta - Seat	Schienali - Backrests	Struttura - Structure	
Rivestimento Upholstering (12)	Sfoderabile / Removable Non sfoderabile / Not removable	Sfoderabile / Removable Non sfoderabile / Not removable	Sfoderabile / Removable Non sfoderabile / Not removable	
Imbottiture Padding (5-6-7-8-9-10-11)	D.35/50kg/m³ memory foam	D.25-30kg/m³	Pol.espanso	ECOSY ETHICALLY SOFT MADE Optional

INFORMAZIONI TECNICHE

Struttura: 1-3

Masselli portanti in legno di abete e faggio di vari spessori. Fianchi di tamponamento in pannelli di particelle di legno in classe E1, particolari in pannelli di fibra di legno dura o cellulosa.

Molleggio: 1-4

Schienale in pannelli di fibra di legno dura o cellulosa. Seduta in nastri elastici di fibra propilenica e lattice.

Note:

Braccioli ALTHON disponibili in rigenerato di cuoio nei colori naturale (CR01), marrone (CR02), tortora (CR03), grigio (CR05), testa di moro (CR08) e canapa (CR10); la cucitura sul bracciolo e' sempre in tinta, nella parte arrotondata sono presenti dei tappi di chiusura in finitura metallo inox (2).

Nella versione in tessuto per l'inserto (14) utilizzare solo il tessuto Miami. Nella versione in pelle inserto non disponibile.

TECHNICAL INFORMATION

Structure: 1-3

Supporting structure in various thickness spruce and beech. Sides and partition in class E1 particleboard panels, details in hardboard panels or cellulose panels.

Springing: 1-4

The back is made of hard or cellulose wooden fibre panels. The seat is supported by propylene and latex elastic belts.

Note:

ALTHON arm available in recycled bonded leather in natural (CR01), brown (CR02), taupe (CR03), grey (CR05), dark brown (CR08), hemp (CR10); the stitching on the arm is in the same shade as the leather, in the rounded part there are closing plugs in stainless steel finish (2).

In the fabric version use only Miami fabric for the insert (14). In the leather version the insert it is not available.

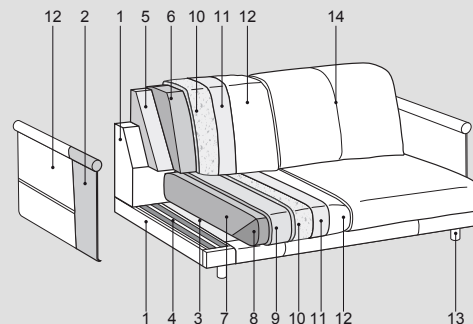
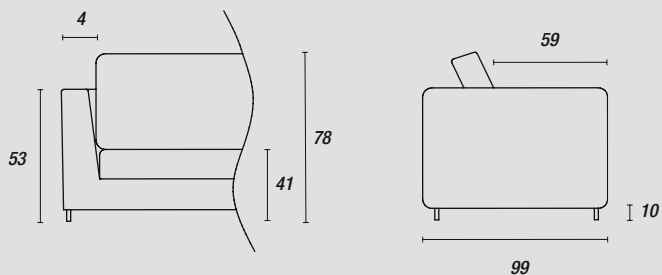

Piedini - Feet:

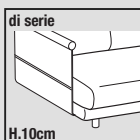

Nero (ME09)

Accessori - Accessories:

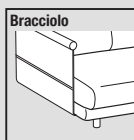

Naturale (CR01)
Marrone (CR02)
Tortora (CR03)
Grigio (CR05)
Testa di Moro (CR08)
Canapa (CR10)

Althon low



	Seduta - Seat	Schienali - Backrests	Struttura - Structure	
Rivestimento Upholstering (12)	Sfoderabile Removable Non sfoderabile Not removable	Sfoderabile Removable Non sfoderabile Not removable	Sfoderabile Removable Non sfoderabile Not removable	
Imbottiture Padding (5-6-7-8-9-10-11)	D.35/50kg/m ³ memory foam	D.25-30kg/m ³	Pol.espanso	ECOSY ETHICALLY SOFT MADE Optional

INFORMAZIONI TECNICHE

Struttura: 1-2-3

Masselli portanti in legno di abete e faggio di vari spessori. Fianchi di tamponamento in pannelli di particelle di legno in classe E1, particolari in pannelli di fibra di legno dura o cellulosa.

Molleggio: 1-4

Schienale in pannelli di fibra di legno dura o cellulosa. Seduta in nastri elastici di fibra propilenica e lattice.

Note:

Braccioli ALTHON disponibili in rigenerato di cuoio nei colori naturale (CR01), marrone (CR02), tortora (CR03), grigio (CR05), testa di moro (CR08) e canapa (CR10); la cucitura sul bracciolo e' sempre in tinta, nella parte arrotondata sono presenti dei tappi di chiusura in finitura metallo inox (2).

Nella versione in tessuto per l'inserto (14) utilizzare solo il tessuto Miami. Nella versione in pelle inserto non disponibile.

TECHNICAL INFORMATION

Structure: 1-2-3

Supporting structure in various thickness spruce and beech. Sides and partition in class E1 particleboard panels, details in hardboard panels or cellulose panels.

Springing: 1-4

The back is made of hard or cellulose wooden fibre panels. The seat is supported by propylene and latex elastic belts.

Note:

ALTHON arm available in recycled bonded leather in natural (CR01), brown (CR02), taupe (CR03), grey (CR05), dark brown (CR08), hemp (CR10); the stitching on the arm is in the same shade as the leather, in the rounded part there are closing plugs in stainless steel finish (2).

In the fabric version use only Miami fabric for the insert (14). In the leather version the insert it is not available.

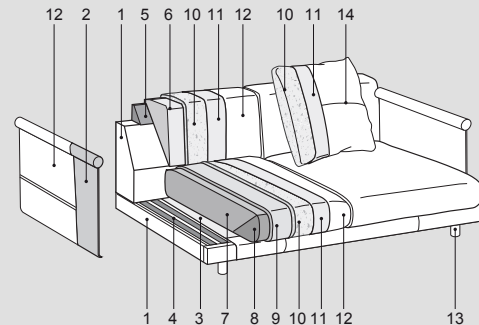
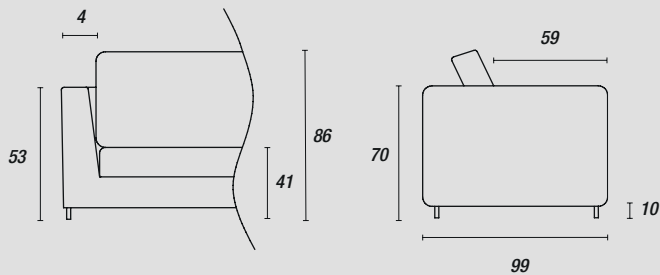

Piedini - Feet:

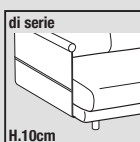

Nero (ME09)

Accessori - Accessories:

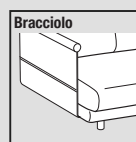

Naturale (CR01)
Marrone (CR02)
Tortora (CR03)
Grigio (CR05)
Testa di Moro (CR08)
Canapa (CR10)