

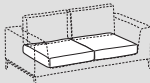

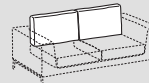

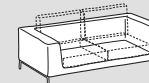





# Kailua



	 Seduta - Seat	 Schienali - Backrests	 Struttura - Structure	
<b>Rivestimento Upholstering (8)</b>	Sfoderabile Removable  	Sfoderabile Removable  	Sfoderabile Removable 	
	Non sfoderabile Not removable -	Non sfoderabile Not removable -	Non sfoderabile Not removable 	
<b>Imbottiture Padding (2-3-4-5-6-7)</b>	 D.50/35kg/m³	 Misto piuma	 Pol.espanso e accoppiato	 Optional

## INFORMAZIONI TECNICHE

### Struttura: 1

Struttura portante telaio in metallo e pannelli di legno multistrato con pannelli di particelle di legno in classe E1 rivestiti in accoppiato.

### Molleggio: 1

Pannelli schienale in particelle di legno in classe E1.  
Pannello seduta in legno multistrato classe E1.

## TECHNICAL INFORMATION

### Structure: 1

Metal pipes and class E1 hardwood plywood supporting framework, class E1 MDF panels armrests covered by interliner.

### Springing: 1

MDF E1 class back panels.  
Hardwood plywood seat panel class E1.

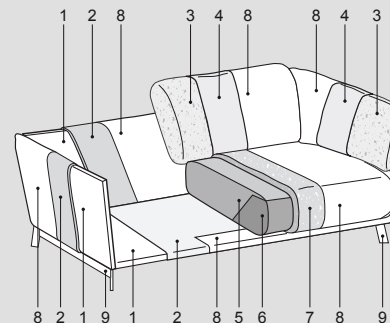
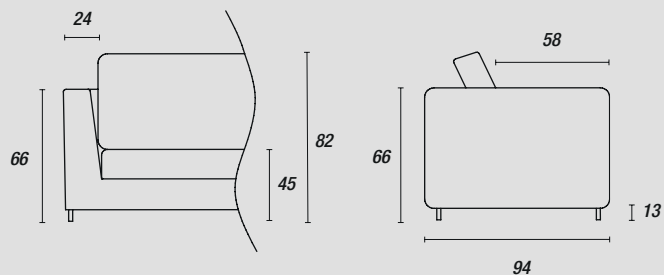

### Piedini - Feet:

#### di serie

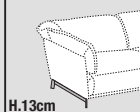

Antracite (ME01)  
Light brown (ME11)



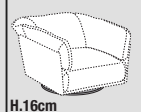





#### di serie

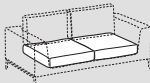
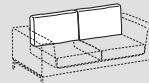
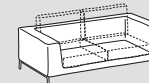

Nero (ME09)

# Kailua mix



	 Seduta - Seat	 Schienali - Backrests	 Struttura - Structure	
<b>Rivestimento Upholstering (8)</b>	Sfoderabile Removable 	Sfoderabile Removable 	-	
	Non sfoderabile Not removable -	Non sfoderabile Not removable -		
<b>Imbottiture Padding (2-3-4-5-6-7)</b>	 D.50/35kg/m³	 Misto piuma	 Pol. espanso accoppiato	 Optional

## INFORMAZIONI TECNICHE

### Struttura: 1

Struttura portante telaio in metallo e pannelli di legno multistrato con pannelli di particelle di legno in classe E1 rivestiti in accoppiato.

### Molleggio: 1

Pannelli schienale in particelle di legno in classe E1.  
Pannello seduta in legno multistrato classe E1.

### Note:

Scocca rivestita in pelle Cat. Soft; per articolo imbottito con parti in pelle di altre categorie, aggiungere la maggiorazione indicata.

## TECHNICAL INFORMATION

### Structure: 1

Metal pipes and class E1 hardwood plywood supporting framework, class E1 MDF panels armrests covered by interliner.

### Springing: 1

MDF E1 class back panels.  
Hardwood plywood seat panel class E1.

### Note:

Base covered with Soft leather; for articles upholstered with leather parts from other categories, consider the indicated surcharge

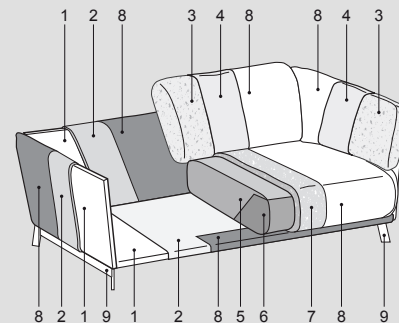
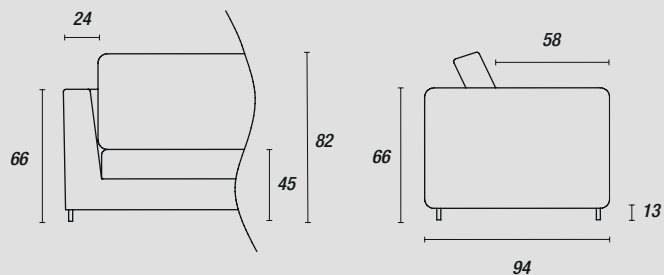

### Piedini - Feet:

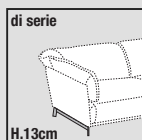

Antracite (ME01)  
Light brown (ME11)

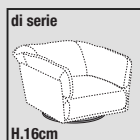

Nero (ME09)