













Epoque fashion

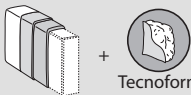

	Seat - Assise	Backrests - Dossiers	Structure - Structure	
Upholstering Revetement (12)	Removable <i>Déhoussable</i>	  	  	
	Not removable <i>Non déhoussable</i>	—	—	 
Padding Rembourrages (2-4-5-6-7-8-9)	 D.35kg/m³	 Mixed feather	 Polyurethane foam + Tecnoform	 ETHICALLY SOFT MADE optional

TECHNICAL INFORMATION

Structure: 1

Supporting frame in class E1 plywood panels and solid spruce or beech wood, with metal support, all wrapped in expanded polyurethane sheets of different densities.

Springing: 1-3

The back is made of hard or cellulose wooden fibre panels. Seat spring with propylene fibre and latex elastic webbing.

Note:

Metal feet (10) and arm profile (11) available in the same color.

The sofas can be attached to side chairs to create different compositions.

For orders of compositions a sketch is requested.

INFORMATIONS TECHNIQUES

Structure: 1

Châssis en panneaux de contreplaqué de bois classe E1 et supports massifs de bois d'épicéa ou de hêtre, soutenu par un support en métal, le tout enveloppé de plaques de polyuréthane expansé à densité différenciée.

Suspension: 1-3

Dossier en panneaux de fibre de bois dure ou cellulose.

Suspension de l'assise avec rubans élastique de fibre propylène et latex.

Note:

Pieds en métal (10) et profils d'accoudoirs (11) disponibles dans le même coloris.

Les canapés peuvent être agencés avec des éléments latéraux pour former des compositions.

Pour commander une composition c'est nécessaire de nous envoyer une schéma.

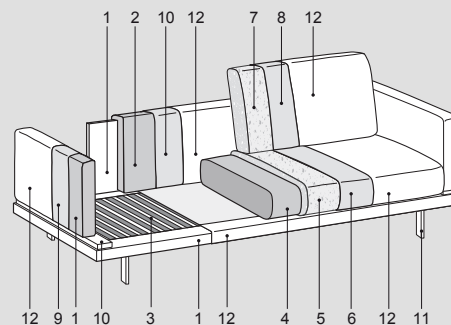
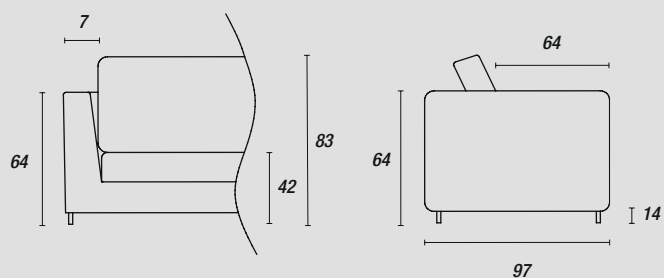

Feet - Pieds::



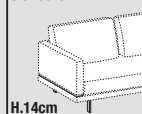



standard

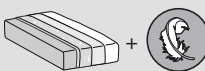

Black (ME09)
Grigio Seta (LE10)

Epoque fashion mix



	Seat - Assise	Backrests - Dossiers	Structure - Structure	
Upholstering Revetement (12)	Removable <i>Déhoussable</i>			-
	Not removable <i>Non déhoussable</i>	-	-	 Cat. Soft
Padding Rembourrages (2-4-5-6-7-8-9)	 D.35kg/m³	 Mixed feather	 Polyurethane foam	 optional

TECHNICAL INFORMATION

Structure: 1

Supporting frame in class E1 plywood panels and solid spruce or beech wood, with metal support, all wrapped in expanded polyurethane sheets of different densities.

Springing: 1-3

The back is made of hard or cellulose wooden fibre panels. Seat spring with propylene fibre and latex elastic webbing.

Note:

Base covered with Soft leather; for articles upholstered with leather parts from other categories, consider the indicated surcharge

Metal feet (10) and arm profile (11) available in the same color.

The sofas can be attached to side chairs to create different compositions.

For orders of compositions a sketch is requested.

INFORMATIONS TECHNIQUES

Structure: 1

Châssis en panneaux de contreplaqué de bois classe E1 et supports massifs de bois d'épicéa ou de hêtre, soutenu par un support en métal, le tout enveloppé de plaques de polyuréthane expansé à densité différenciée.

Suspension: 1-3

Dossier en panneaux de fibre de bois dure ou cellulose.

Suspension de l'assise avec rubans élastique de fibre propylène et latex.

Note:

Structure revêtue en cuir cat. Soft; pour l'article rembourré avec des parties dans d'autres catégories de cuir, rajouter la majoration qui est indiquée.

Pieds en métal (10) et profils d'accoudoirs (11) disponibles dans le même coloris.

Les canapés peuvent être agencés avec des éléments latéraux pour former des compositions.

Pour commander une composition c'est nécessaire de nous envoyer un schéma.

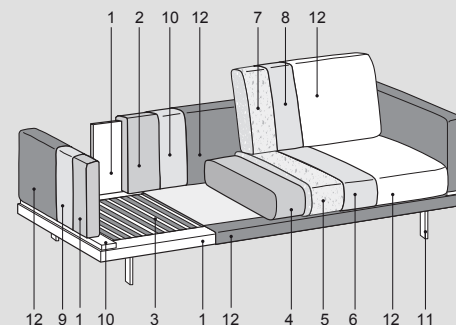
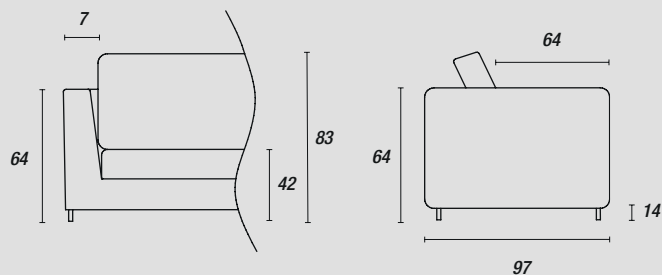

Feet - Pieds::

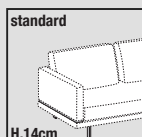

Black (ME09)
Grigio Seta (LE10)