













	Seat - Assise	Backrests - Dossiers	Structure - Structure	
Upholstering <i>Revetement</i> (8)	Removable <i>Déhoussable</i>	 		
	Not removable <i>Non déhoussable</i>	—		
Padding <i>Rembourrages</i> (4-5-6-7)	 D.35kg/m³	 D.21kg/m³	 D.21kg/m³ Tecnoform	 optional

TECHNICAL INFORMATION

Structure: 1-2

Solid spruce and beech wood supports in various thicknesses. Buffer side in class E1 plywood and particleboard panels; details in hard or cellulose wood fibre panels.

Springing: 1-3

Backrests in hard or cellulose fibreboard panels, and pre-tensioned propylene and latex elastic webbing.

Seat with pre-tensioned crossed propylene fibre and latex elastic webbing.

Note:

The back has a metal clutch mechanism inside (10) with lifting/lowering function into the desired position. These articles are available also with fixed armrest/armrests without mechanism, in this case consider the lower width overall dimension.

INFORMATIONS TECHNIQUES

Structure: 1-2

Support en bois d'épicéa et de hêtre de différentes épaisseurs. Côtés de compensation en panneaux de contreplaqué de bois et panneaux de particules de bois de classe E1, détails en panneaux de fibre de bois dur ou cellulose.

Suspension: 1-3

Dossiers en panneaux de fibre de bois dur ou cellulose et rubans élastique de fibre propylène et latex, mécaniquement pré-tensionnés.

Assise en rubans élastique de fibre propylène et latex croisés et mécaniquement pré-tensionnés.

Note:

Les dossiers ont à leur intérieur une mécanique embrayé (10) qui permet la fonction de soulèvement et abaissement du dossier, dans la position souhaité. Sont disponibles articles avec accoudoir/accoudoirs fixes sans mécanisme, dans ce cas considerer la dimension hors tout la moins large.

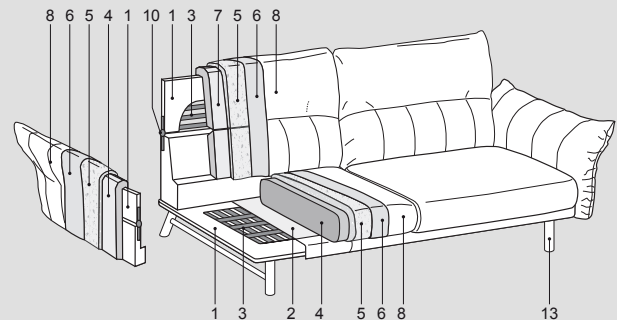
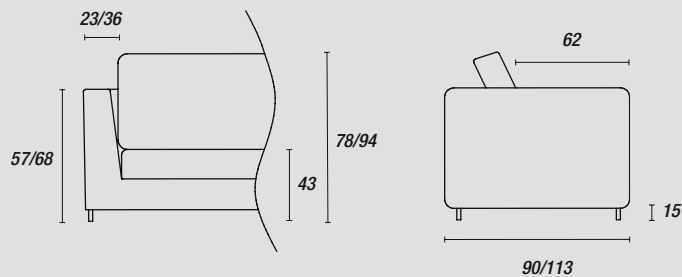

Feet - Pieds::

standard ONLINE

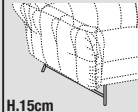

H.15cm

Black (ME09)
Light brown (ME11)

optional Plain



H.15cm

Black (ME09)