













Arlott high

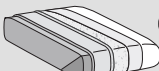

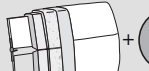
	Seduta - Seat	Schienali - Backrests	Struttura - Structure	
Rivestimento Upholstering (11)	Sfoderabile Removable  	Sfoderabile Removable 	Sfoderabile Removable 	
	Non sfoderabile Not removable —	Non sfoderabile Not removable 	Non sfoderabile Not removable 	
Imbottiture Padding (4-5-6-7-8-9-10)	  D.35/40kg/m³	  D.21kg/m³	  Pol.espanso	 Optional

INFORMAZIONI TECNICHE

Struttura: 1-2-4

Masselli portanti in legno di abete e faggio di vari spessori. Fianchi di tamponamento in pannelli di legno multistrati e particelle di legno in classe E1, particolari in pannelli di fibra di legno dura o cellulosa.

Molleggio: 1-3

Schienale in pannelli di fibra di legno dura o cellulosa.

Seduta in nastri elastici di fibra propilenica e lattice incrociati e meccanicamente pretensionati.

Note:

Meccanismo del poggiatesta (12) in acciaio cromato regolabile in 6 posizioni con meccanismo manuale.

Barra anteriore (14) in metallo disponibile nelle finiture colore nero (ME 09) o Light Brown (ME11) oppure con rivestimento in pelle nei vari colori e tipologie disponibili a campionario.

TECHNICAL INFORMATION

Structure: 1-2-4

Solid spruce and beech wood supports in various thicknesses. Buffer side in class E1 plywood and particleboard panels; details in hard or cellulose wood fibre panels.

Springing: 1-3

The back is made of hard or cellulose wooden fibre panels.

Seat with pre-tensioned crossed propylene fibre and latex elastic webbing.

Note:

Chromed steel headrest (12) mechanism 6 positions adjustable with manual mechanism.

Metal front bar (14) available in black (ME 09) or light brown (ME 11) finishes or with leather upholstery in the various colors and types available in the color chart

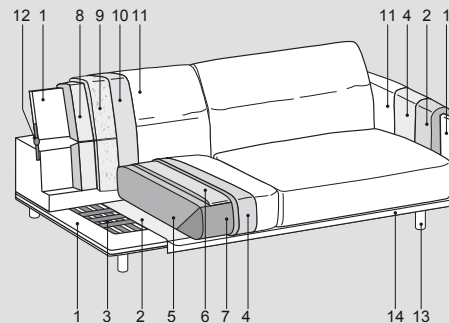
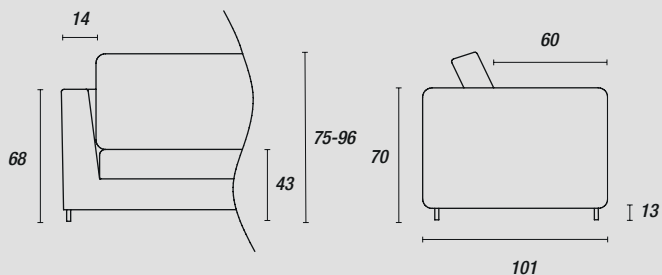

Piedini - Feet:

di serie Tail

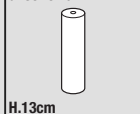

H.13cm

Nero (ME09)
Light brown (ME11)