

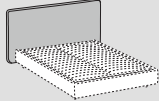

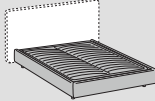

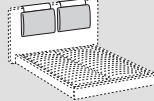





Bend



	 Testiera - Headboard	 Giroletto - Bed frame	 Cuscini - Cushions
Rivestimento Upholstering (7) Sfoderabile <i>Removable</i>			
Non sfoderabile <i>Not removable</i>		-	-
Imbottiture Padding (3-4-5-6)	 +  Accoppiato D.30kg/m ³	 +  Tecnoform & Accoppiato D.30/40kg/m ³	 +  Tecnoform D.21kg/m ³

INFORMAZIONI TECNICHE

Struttura: 1-2

Testiera in pannelli di legno multistrato in classe E1, longoni e pediera in pannelli di particelle di legno in classe E1.

Note:

Per finitura bicolore in tessuto, considerare il prezzo della categoria più alta dei rivestimenti utilizzati.

Possibilità di regolare l'altezza della rete su cui appoggia il materasso nei letti fissi privi di meccanismo.

Caratteristiche relative ai materiali utilizzati descritte nella sezione tecnica a fine listino. Coprirete disponibile nella sezione accessori per letti.

TECHNICAL INFORMATION

Structure: 1-2

Headboard in class E1 plywood panels; frame members and footboard in class E1 particleboard panels.

Note:

For fabric two-colour finish, please consider the price of the more expensive category of fabric used.

Height-adjustment option for the bedbase that supports the mattress, allowing total or partial integration for beds without mechanism.

For characteristics of the used materials, see the technical section. Bed-base cover set available in the section "Bed accessories"

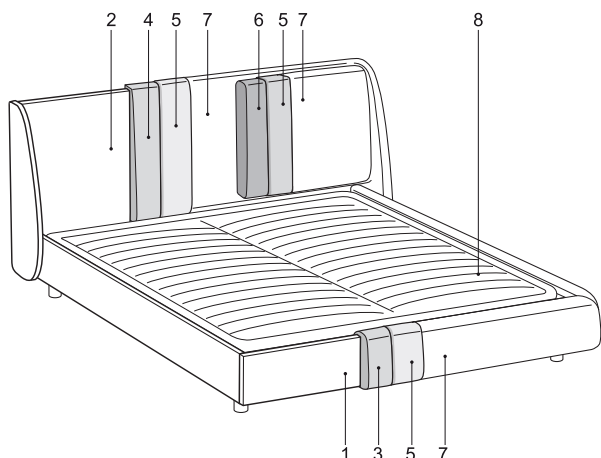

Versioni disponibili (per dimensioni selezionate)
 Available versions (by selected dimensions)

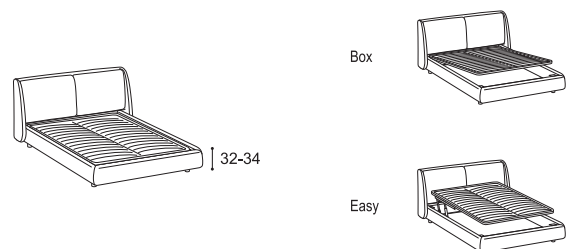



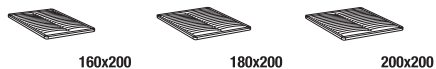





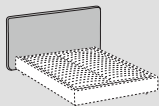
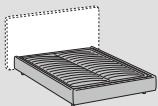
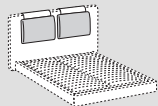

Disponibile per materasso da:
 Available for mattress:



Bend mix



	 Testiera - Headboard	 Giroletto - Bed frame	 Cuscini - Cushions
Rivestimento Upholstering (7)	Sfoderabile Removable -		
	Non sfoderabile Not removable 	-	-
Imbottiture Padding (3-4-5-6)	 +  Accoppiato D.30kg/m³	 +  Tecnoform & Accoppiato D.30/40kg/m³	 +  Tecnoform D.21kg/m³

INFORMAZIONI TECNICHE

Struttura: 1-2

Testiera in pannelli di legno multistrato abbinati a pannelli di particelle di legno tutti in classe E1, longoni e pediera in pannelli di particelle di legno in classe E1 e spessori in pannelli di osb.

Note:

Testiera e giroletto rivestiti in pelle Cat. Soft, cuscini della testiera rivestiti in tessuto; per letto con parti in pelle di altre categorie aggiungere la maggiorazione indicata.

Possibilità di regolare l'altezza della rete su cui appoggia il materasso nei letti fissi privi di meccanismo.

Caratteristiche relative ai materiali utilizzati descritte nella sezione tecnica a fine listino.

Coprirete disponibile nella sezione accessori per letti.

TECHNICAL INFORMATION

Structure: 1-2

Headboard in plywood panels combined with entirely class E1 particleboard panels; frame members and footboard in class E1 particleboard panels and shims in OSB panels.

Note:

Headboard and bed frame covered in Soft Cat. leather, headboard cushions in fabric; for bed with leather parts from other categories, please add the indicated surcharge.

Height-adjustment option for the bedbase that supports the mattress, allowing total or partial integration for beds without mechanism.

For characteristics of the used materials, see the technical section.

Bed-base cover set available in the section "Bed accessories"

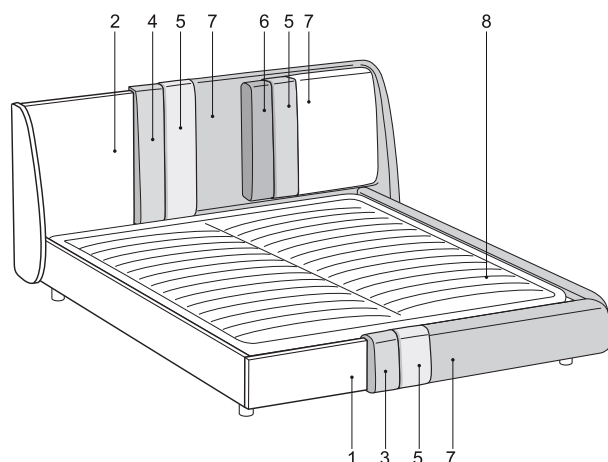

Versioni disponibili (per dimensioni selezionate)

Available versions (by selected dimensions)

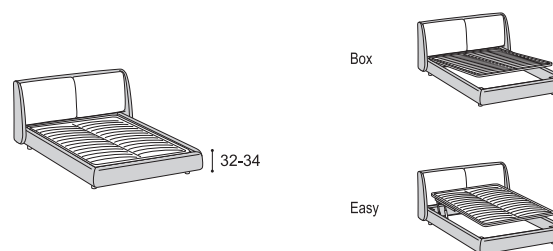

Disponibile per materasso da:
 Available for mattress:

