

Skin



	Seduta - Seat	Schienali - Backrests	Base - Base	
Rivestimento Upholstering (11)	Sfoderabile Removable	Sfoderabile Removable	Sfoderabile Removable	
	Non sfoderabile Not removable	Non sfoderabile Not removable	Non sfoderabile Not removable	
Imbottiture Padding (4-5-6-7-8-9-10)	 D.35/40kg/m³ memory foam & Tecnoform	 D.25kg/m³	 Accoppiato	 Optional

INFORMAZIONI TECNICHE

Struttura: 1-2

Struttura base in pannelli di legno multistrati in classe E1. Masselli portanti in legno di abete. Elementi strutturali in pannelli di legno multistrati in classe E1 e tamponamenti in faesite. Bracciolo in legno multistrati curvato.

Molleggio: 1-3

Schienale in nastri elastici di fibra propilenica e lattice meccanicamente pretensionati. Seduta in nastri elastici di fibra propilenica e lattice incrociati e meccanicamente pretensionati.

Note:

Pannello bracciolo non sfoderabile.
Tavolino Skin in metallo verniciato.

TECHNICAL INFORMATION

Structure: 1-2

Frame structure in plywood panels in class E1. Solid fir wood. Structural elements in plywood panels in class E1 and infill in faesite. Curved plywood armrest.

Springing: 1-3

Backrest with pre-tensioned elastic strips in propylene fibre and latex. Seat with pre-tensioned crossed propylene fibre and latex elastic webbing.

Note:

Armrest panel cover non removable
Metal varnished Skin small table

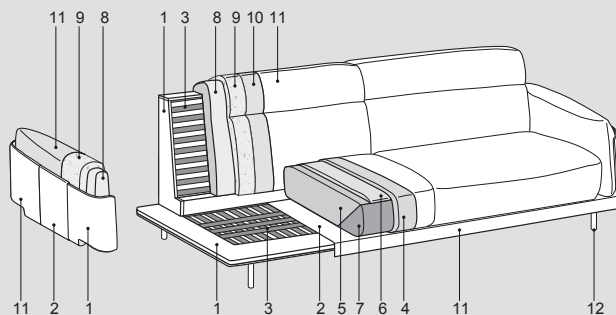
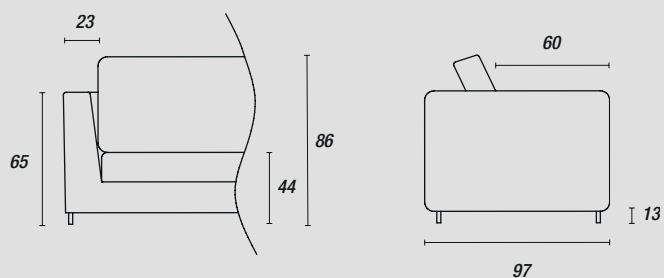

Piedini - Feet:

di serie Tail

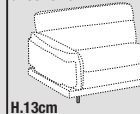

Nero (ME09)
Light brown (ME11)

optional slitta Skin

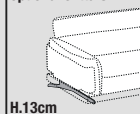

con maggiorazione
Nero (ME09)
Light brown (ME11)

Accessori - Accessories:

Tavolino







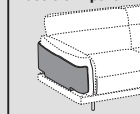

Nero (ME09)
Light brown (ME11)
Petro (ME13)

Bracciolo in pelle

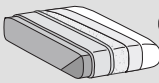

Skin mix



	Seduta - Seat	Schienali - Backrests	Base - Base	
Rivestimento Upholstering (11)	Sfoderabile Removable 	Sfoderabile Removable 	Non sfoderabile Not removable 	
Imbottiture Padding (4-5-6-7-8-9-10)	 D.35/40kg/m³	 D.25kg/m³	 Accoppiato	 Optional

INFORMAZIONI TECNICHE

Struttura: 1-2

Struttura base in pannelli di legno multistrati in classe E1. Masselli portanti in legno di abete. Elementi strutturali in pannelli di legno multistrati in classe E1 e tamponamenti in faesite. Bracciolo in legno multistrati curvato.

Molleggio: 1-3

Schienale in nastri elastici di fibra propilenica e lattice meccanicamente pretensionati. Seduta in nastri elastici di fibra propilenica e lattice incrociati e meccanicamente pretensionati.

Note:

Pannello bracciolo non sfoderabile.
Tavolino Skin in metallo verniciato.

TECHNICAL INFORMATION

Structure: 1-2

Frame structure in plywood panels in class E1. Solid fir wood. Structural elements in plywood panels in class E1 and infill in faesite. Curved plywood armrest.

Springing: 1-3

Backrest with pre-tensioned elastic strips in propylene fibre and latex. Seat with pre-tensioned crossed propylene fibre and latex elastic webbing.

Note:

Armrest panel cover non removable
Metal varnished Skin small table

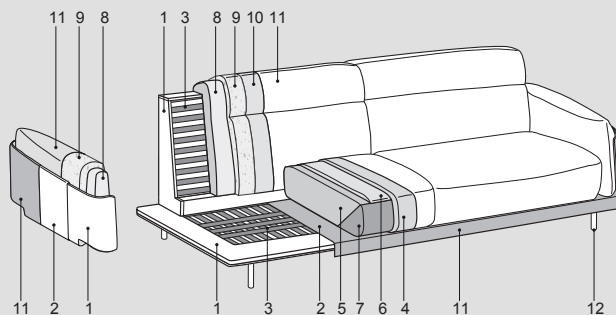
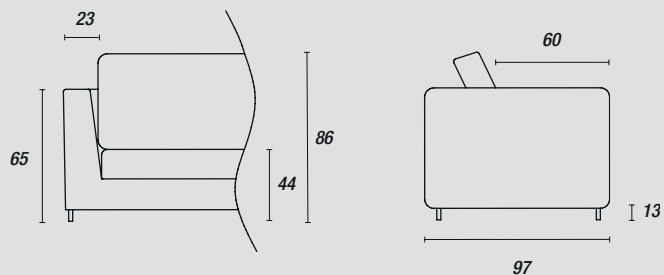

Piedini - Feet:

di serie Tail

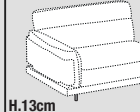

Nero (ME09)
Light brown (ME11)

optional slitta Skin

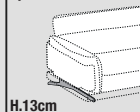

con maggiorazione
Nero (ME09)
Light brown (ME11)

Accessori - Accessories:

Tavolino



Nero (ME09)
Light brown (ME11)
Petro (ME13)