

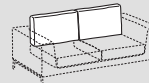

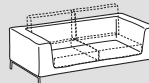









 Sitzkissen - <i>Seduta</i>	 Rückenkissen - <i>Schienali</i>	 Gestell - <i>Struttura</i>	
Bezug: Rivestimento (9)	abziehbar <i>Sfoderabile</i>   	  		
nicht abziehbar <i>Non sfoderabile</i>	—	—	 	
Polsterungen Imbottiture (4-5-6-7-8)	 D.35kg/m³	 D.21kg/m³	 Polyurethanschaumstoff	 optional

TECHNISCHE BESCHREIBUNG

Gestell: 1

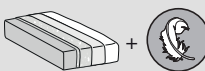
Tragende Struktur aus Mehrschichtplatte und Tannenholz.

Federung: 1-2

Rückenlehne aus Schichtholzplatten oder Holzfasern Klasse E1.
Sitz in gekreuzten und mechanisch vorgespannten elastischen Bändern aus Propylenfaser und Latex.

INFORMAZIONI TECNICHE

Struttura: 1

Struttura portante in pannelli di legno listellare multistrato e masselli portanti in abete di vari spessori.

Molleggio: 1-2

Schienale in pannello in multistrati di legno o di particelle di legno in classe E1.
Seduta in nastri elastici di fibra propilenica e lattice incrociati e meccanicamente pretensionati.

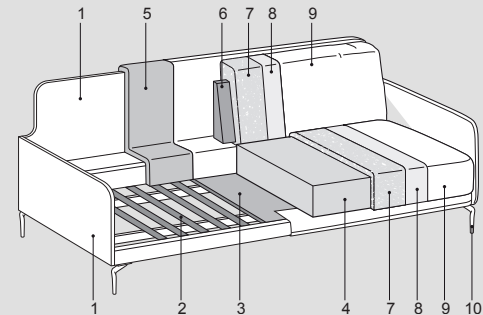
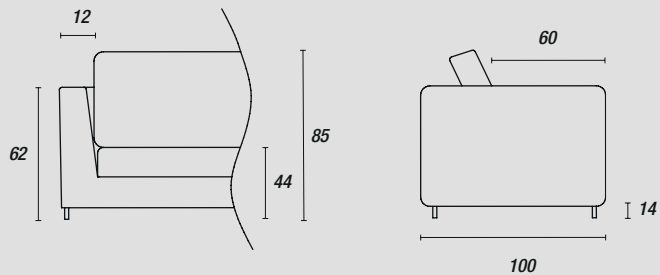

Füße - Piedini:

serienmäßig TAG

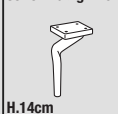

H.14cm
Schwarzes Metall (ME09)
Light brown (ME11)

optional UP



gegen Aufpreis
Schwarzes Metall (ME09)
Light brown (ME11)

optional Bjorg

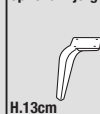

H.13cm
Schwarzes Metall (ME09)
Light brown (ME11)
Anthrazit (ME01)
Dunkelbraun (ME03)

optional Bjorg

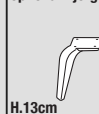

gegen Aufpreis
Glänzendes Chrom (ME04)
Schwarz verchromt (ME05)





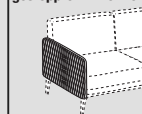

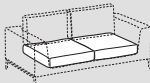
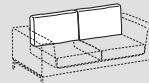
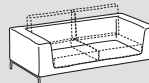

Zubehör - Accessori:

gesteppte Armlehne

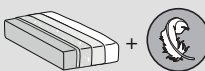

Krisby mix



	 Sitzkissen - <i>Seduta</i>	 Rückenkissen - <i>Schienali</i>	 Gestell - <i>Struttura</i>	
Bezug: Rivestimento (9)	abziehbar <i>Sfoderabile</i> 	abziehbar <i>Sfoderabile</i> 	-	
	nicht abziehbar <i>Non sfoderabile</i> -	nicht abziehbar <i>Non sfoderabile</i> -		
Polsterungen Imbottiture (4-5-6-7-8)	 D.35kg/m³	 D.21kg/m³	 Tecnoform Polyurethanschaumstoff	 ETHICALLY SOFT MADE optional

TECHNISCHE BESCHREIBUNG

Gestell: 1

Tragende Struktur aus Mehrschichtplatte und Tannenholz.

Federung: 1-2

Rückenlehne aus Schichtholzplatten oder Holzfasern Klasse E1.
Sitz in gekreuzten und mechanisch vorgespannten elastischen Bändern aus Propylenfaser und Latex.

Hinweis

Korpus in Leder Kat. Soft; für Polsterartikel mit Lederteilen anderer Kategorien den angegebenen Zuschlag hinzufügen. Borte serienmäßig Ton in Ton, wenn im Kontrast die Farbe angeben.

INFORMAZIONI TECNICHE

Struttura: 1

Struttura portante in pannelli di legno listellare multistrato e masselli portanti in abete di vari spessori.

Molleggio: 1-2

Schienale in pannello in multistrati di legno o di particelle di legno in classe E1.
Seduta in nastri elastici di fibra propilenica e lattice incrociati e meccanicamente pretensionati.

Note:

Scocca rivestita in pelle Cat. Soft; per articolo imbottito con parti in pelle di altre categorie, aggiungere la maggiorazione indicata. Bordo di serie tono su tono, se in contrasto specificare il colore.

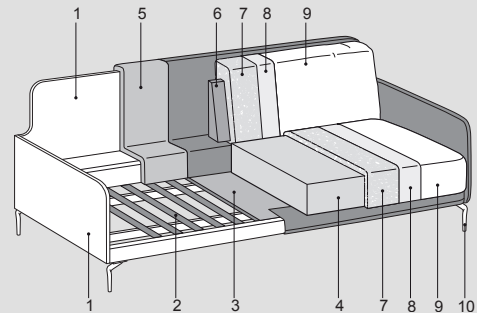
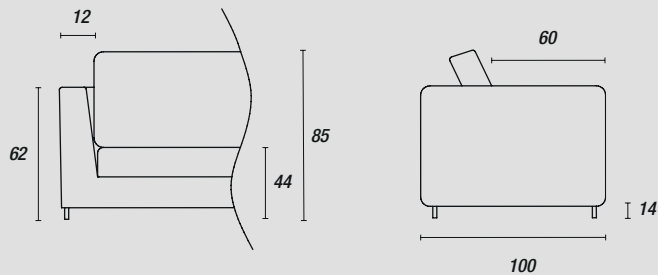

Füße - Piedini:

serienmäßig TAG



H.14cm
Schwarzes Metall (ME09)
Light brown (ME11)

optional UP



H.14-19cm
gegen Aufpreis
Schwarzes Metall (ME09)
Light brown (ME11)

optional Bjorg



H.13cm
Schwarzes Metall (ME09)
Light brown (ME11)
Anthrazit (ME01)
Dunkelbraun (ME03)

optional Bjorg



H.13cm
gegen Aufpreis
Glänzendes Chrom (ME04)
Schwarz verchromt (ME05)

Zubehör - Accessori:

gesteppte Armlehne

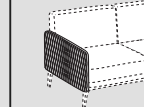

Krisby low



	Sitzkissen - Seduta	Rückenkissen - Schienali	Gestell - Struttura	
Bezug: Rivestimento (9)	abziehbar <i>Sfoderabile</i> Fabric, Artificial Leather	Fabric, Artificial Leather	Fabric	
nicht abziehbar <i>Non sfoderabile</i>	-	-	Artificial Leather	
Polsterungen Imbottiture (4-5-6-7-8)	D.35kg/m³	D.21kg/m³	Polyurethanschaumstoff + Tecnoform	ECOSY ETHICALLY SOFT MADE optional

TECHNISCHE BESCHREIBUNG

Gestell: 1

Tragende Struktur aus Mehrschichtplatte und Tannenholz.

Federung: 1-2

Rückenlehne aus Schichtholzplatten oder Holzfaserplatten Klasse E1.
Sitz in gekreuzten und mechanisch vorgespannten elastischen Bändern aus Propylenfaser und Latex.

INFORMAZIONI TECNICHE

Struttura: 1

Struttura portante in pannelli di legno listellare multistrato e masselli portanti in abete di vari spessori.

Molleggio: 1-2

Schienale in pannello in multistrati di legno o di particelle di legno in classe E1.
Seduta in nastri elastici di fibra propilenica e lattice incrociati e meccanicamente pretensionati.

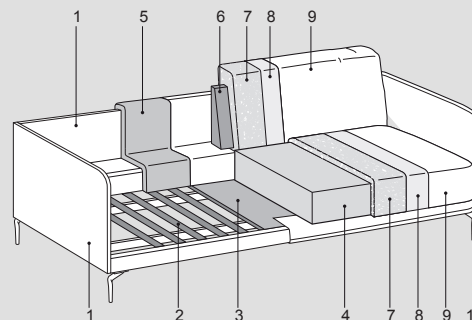
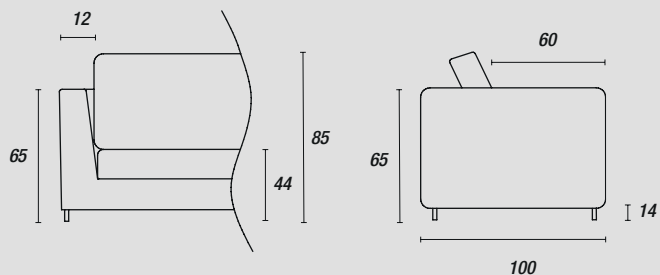

Füße - Piedini:

serienmäßig TAG

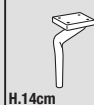

H.14cm
Schwarzes Metall (ME09)
Light brown (ME11)

optional UP



gegen Aufpreis
Schwarzes Metall (ME09)
Light brown (ME11)

optional Bjorg

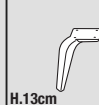

H.13cm
Schwarzes Metall (ME09)
Light brown (ME11)
Anthrazit (ME01)
Dunkelbraun (ME03)

optional Bjorg

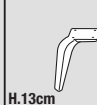

gegen Aufpreis
Glänzendes Chrom (ME04)
Schwarz verchromt (ME05)





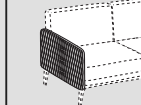

Zubehör - Accessori:

gesteppte Armlehne

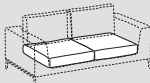
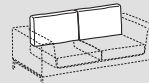
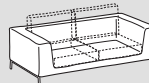

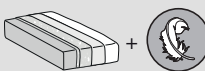
Krisby mix low



	 Sitzkissen - <i>Seduta</i>	 Rückenkissen - <i>Schienali</i>	 Gestell - <i>Struttura</i>	
Bezug: Rivestimento (9)	abziehbar <i>Sfoderabile</i> 	abziehbar <i>Sfoderabile</i> 	-	
	nicht abziehbar <i>Non sfoderabile</i> -	nicht abziehbar <i>Non sfoderabile</i> -	-	
Polsterungen Imbottiture (4-5-6-7-8)	 D.35kg/m³	 D.21kg/m³	 Polyurethanschaumstoff	 optional

TECHNISCHE BESCHREIBUNG

Gestell: 1

Tragende Struktur aus Mehrschichtplatte und Tannenholz.

Federung: 1-2

Rückenlehne aus Schichtholzplatten oder Holzfasern Klasse E1. Sitz in gekreuzten und mechanisch vorgespannten elastischen Bändern aus Propylenfaser und Latex.

Hinweis

Korpus in Leder Kat. Soft; für Polsterartikel mit Lederteilen anderer Kategorien den angegebenen Zuschlag hinzufügen. Borte serienmäßig Ton in Ton, wenn im Kontrast die Farbe angeben.

INFORMAZIONI TECNICHE

Struttura: 1

Struttura portante in pannelli di legno listellare multistrato e masselli portanti in abete di vari spessori.

Molleggio: 1-2

Schienale in pannello in multistrati di legno o di particelle di legno in classe E1. Seduta in nastri elastici di fibra propilenica e lattice incrociati e meccanicamente pretensionati.

Note:

Scocca rivestita in pelle Cat. Soft; per articolo imbottito con parti in pelle di altre categorie, aggiungere la maggiorazione indicata. Bordo di serie tono su tono, se in contrasto specificare il colore.

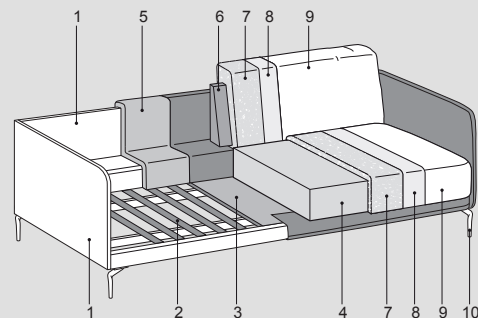
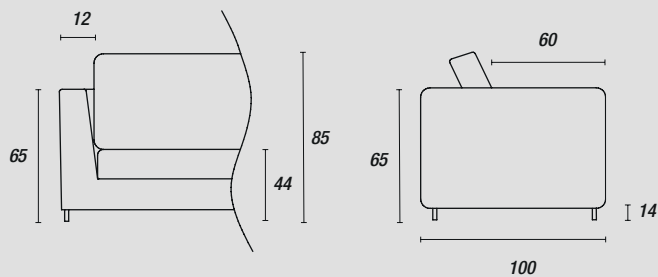

Füße - Piedini:

serienmäßig TAG



H.14cm
Schwarzes Metall (ME09)
Light brown (ME11)

optional UP

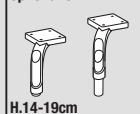

gegen Aufpreis
Schwarzes Metall (ME09)
Light brown (ME11)

optional Bjorg



H.13cm
Schwarzes Metall (ME09)
Light brown (ME11)
Anthrazit (ME01)
Dunkelbraun (ME03)

optional Bjorg



gegen Aufpreis
Glänzendes Chrom (ME04)
Schwarz verchromt (ME05)

Zubehör - Accessori:

gesteppte Armlehne

