

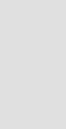









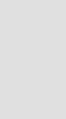
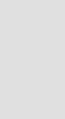

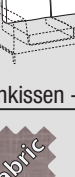
	Sitzkissen - <i>Seduta</i>	Rückenkissen - <i>Schienali</i>	Gestell - <i>Struttura</i>	
Bezug: Rivestimento (10)	abziehbar <i>Sfoderabile</i>	Fabric  	Fabric  	Fabric 
	nicht abziehbar <i>Non sfoderabile</i>	-	-	
Polsterungen Imbottiture (2-4-5-6-7-8-9)	   D.35/50kg/m ³	  Daunen und Polyesterfaser gemischt	 +  Polyurethanschaumstoff	 ETHICALLY SOFT MADE optional

TECHNISCHE BESCHREIBUNG

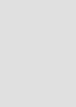
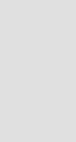
Gestell: 1

Tragkonstruktion aus Holzfasernplatten der Klasse E1 und Massivholzträgern aus Fichten- oder Buchenholz auf einem Metallträger und umhüllt mit PUR-Schaumstoffplatten mit unterschiedlicher Dichte.

Federung: 1-4

Rückenlehne aus harten Holzfasern oder Zellulose.

Sitz in gekreuzten und mechanisch vorgespannten elastischen Bändern aus Propylenfaser und Latex.

INFORMAZIONI TECNICHE

Struttura: 1

Struttura portante in pannelli di multistrato di legno classe E1 e masselli di legno di abete o faggio, sostenuta da supporto in metallo, il tutto avvolto da lastre di poliuretano espanso a densità differenziate.

Molleggio: 1-4

Schienale in pannelli di fibra di legno dura o cellulosa.

Seduta in nastri elastici di fibra propilenica e lattice incrociati e meccanicamente pretensionati.

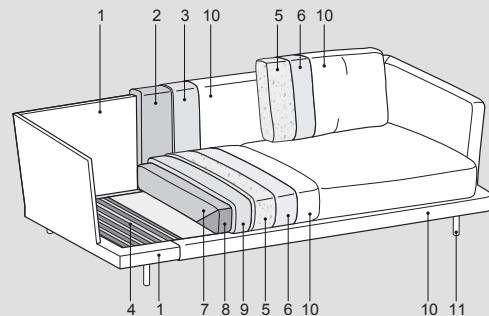
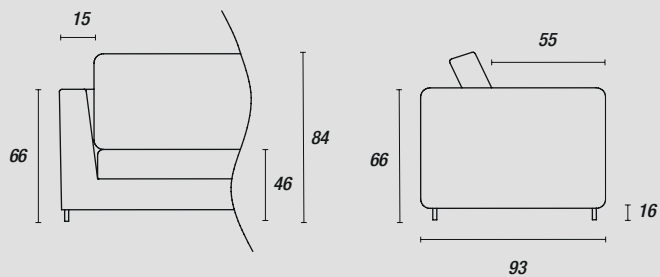

Füße - Piedini:

serienmäßig VOIP

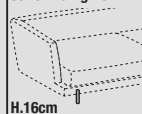

Schwarzes Metall (ME09)
Light brown (ME11)



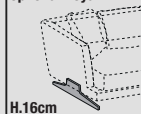





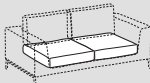
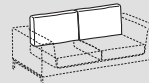
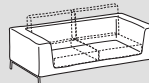

optional Royal



gegen Aufpreis
Schwarzes Metall (ME09)
Light brown (ME11)

Royal soft



	 Sitzkissen - <i>Seduta</i>	 Rückenkissen - <i>Schienali</i>	 Gestell - <i>Struttura</i>	
Bezug: Rivestimento (10)	abziehbar <i>Sfoderabile</i>	 	 	
	nicht abziehbar <i>Non sfoderabile</i>	—	—	
Polsterungen Imbottiture (2-3-5-6-7-8-9)	 memory foam	 Daunen und Polyesterfaser gemischt	 Tecnoform Polyurethanschaumstoff	 ETHICALLY SOFT MADE optional
	D.35/50kg/m ³			

TECHNISCHE BESCHREIBUNG

Gestell: 1

Tragkonstruktion aus Holzfasernplatten der Klasse E1 und Massivholzträgern aus Fichten- oder Buchenholz auf einem Metallträger und umhüllt mit PUR-Schaumstoffplatten mit unterschiedlicher Dichte.

Federung: 1-4

Rückenlehne aus harten Holzfasern oder Zellulose.

Sitz in gekreuzten und mechanisch vorgespannten elastischen Bändern aus Propylenfaser und Latex.

INFORMAZIONI TECNICHE

Struttura: 1

Struttura portante in pannelli di multistrato di legno classe E1 e masselli di legno di abete o faggio, sostenuta da supporto in metallo, il tutto avvolto da lastre di poliuretano espanso a densità differenziate.

Molleggio: 1-4

Schienale in pannelli di fibra di legno dura o cellulosa.

Seduta in nastri elastici di fibra propilenica e lattice incrociati e meccanicamente pretensionati.

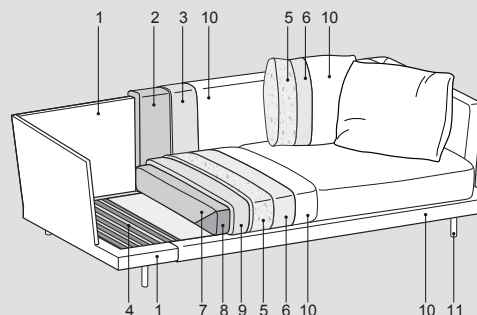
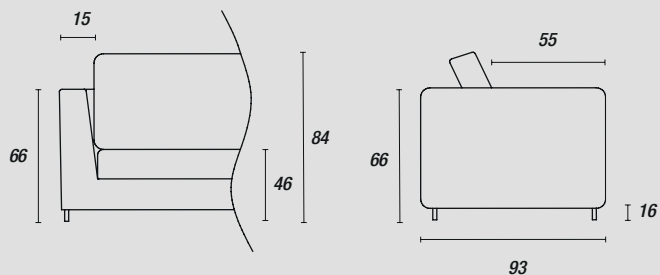

Füße - Piedini:

serienmäßig VOIP

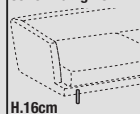

Schwarzes Metall (ME09)
Light brown (ME11)

optional Royal

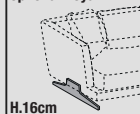

gegen Aufpreis
Schwarzes Metall (ME09)
Light brown (ME11)