











Skin

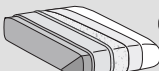

	Sitzkissen - <i>Seduta</i>	Rückenkissen - <i>Schienali</i>	Basis - <i>Base</i>	
Bezug: Rivestimento (11)	abziehbar <i>Sfoderabile</i>			
	 			
	nicht abziehbar <i>Non sfoderabile</i>			
	—			
Polsterungen Imbottiture (4-5-6-7-8-9-10)	  D.35/40kg/m³	 D.25kg/m³	 Vlies	 optional

TECHNISCHE BESCHREIBUNG

Gestell: 1-2

Tragkonstruktion aus Holzfaserverplatten der Klasse E1 und Massivholzträgern aus Fichten- oder Buchenholz. Seitliche Verblendungen aus mehrschichtigen Holzplatten und Holzpartikeln der Klasse E1, Details aus Hartholzfaserverplatten oder Zellulose. Armlehne aus gebogenem Mehrschichtholz.

Federung: 1-3

Rückenlehne aus mechanisch vorgespannten Propylenfaser- und Latex-Elastikgurten. Sitz in gekreuzten und mechanisch vorgespannten elastischen Bändern aus Propylenfaser und Latex.

Hinweis

Armlehnenpaneele nicht abziehbar
Skin Lackierter Metalltisch

INFORMAZIONI TECNICHE

Struttura: 1-2

Struttura portante in pannelli di legno multistrato in classe E1, masselli in legno di abete e faggio di vari spessori. Fianchi di tamponamento in pannelli di legno multistrato e particelle di legno in classe E1, particolari in pannelli di fibra di legno dura o cellulosa. Bracciolo in legno multistrato curvato.

Molleggio: 1-3

Schienale in nastri elastici di fibra propilenica e lattice meccanicamente pretensionati. Seduta in nastri elastici di fibra propilenica e lattice incrociati e meccanicamente pretensionati.

Note:

Pannello bracciolo non sfoderabile.
Tavolino Skin in metallo verniciato.

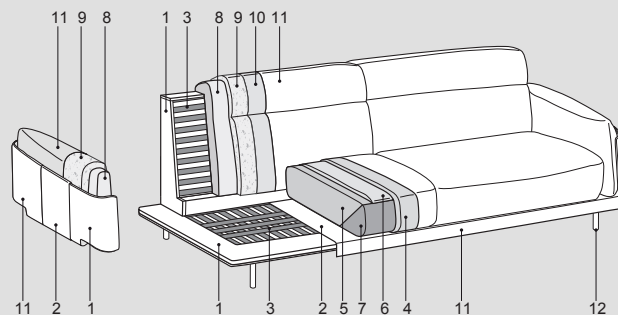
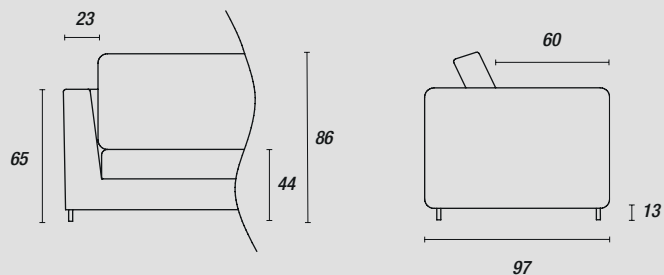

Füße - Piedini:

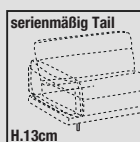

Schwarzes Metall (ME09)
Light brown (ME11)



gegen Aufpreis
Schwarzes Metall (ME09)
Light brown (ME11)

Zubehör - Accessori:

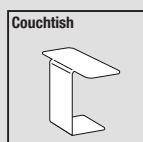



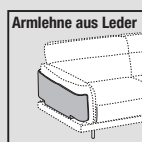



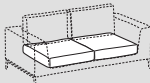
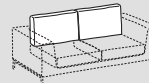
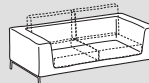

Schwarzes Metall (ME09)
Light brown (ME11)

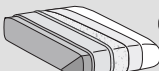

Skin mix



	 Sitzkissen - <i>Seduta</i>	 Rückenkissen - <i>Schienali</i>	 Basis - <i>Base</i>	
Bezug: Rivestimento (11)	abziehbar <i>Sfoderabile</i> 	Rückenkissen - <i>Schienali</i> 	Basis - <i>Base</i> -	
	nicht abziehbar <i>Non sfoderabile</i> -	-		
Polsterungen Imbottiture (4-5-6-7-8-9-10)	 D.35/40kg/m³  memory foam & Tecnoform	 D.25kg/m³	 Vlies	 optional

TECHNISCHE BESCHREIBUNG

Gestell: 1-2

Tragkonstruktion aus Holzfaserverplatten der Klasse E1 und Massivholzträgern aus Fichten- oder Buchenholz. Seitliche Verblendungen aus mehrschichtigen Holzplatten und Holzpartikeln der Klasse E1, Details aus Hartholzfaserverplatten oder Zellulose. Armlehne aus gebogenem Mehrschichtholz.

Federung: 1-3

Rückenlehne aus mechanisch vorgespannten Propylenfaser- und Latex-Elastikgurten. Sitz in gekreuzten und mechanisch vorgespannten elastischen Bändern aus Propylenfaser und Latex.

Hinweis

Armlehnenpaneele nicht abziehbar
Skin Lackierter Metalltisch

INFORMAZIONI TECNICHE

Struttura: 1-2

Struttura portante in pannelli di legno multistrato in classe E1, masselli in legno di abete e faggio di vari spessori. Fianchi di tamponamento in pannelli di legno multistrati e particelle di legno in classe E1, particolari in pannelli di fibra di legno dura o cellulosa. Bracciolo in legno multistrato curvato.

Molleggio: 1-3

Schienale in nastri elastici di fibra propilenica e lattice meccanicamente pretensionati. Seduta in nastri elastici di fibra propilenica e lattice incrociati e meccanicamente pretensionati.

Note:

Pannello bracciolo non sfoderabile.
Tavolino Skin in metallo verniciato.

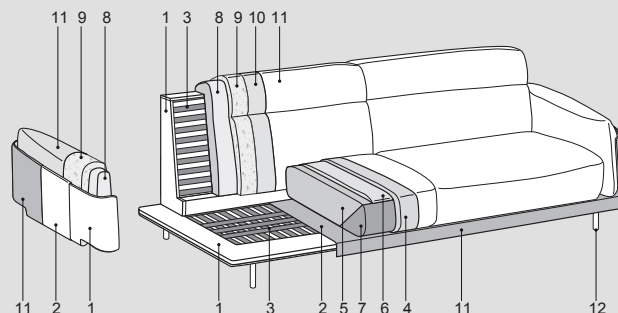
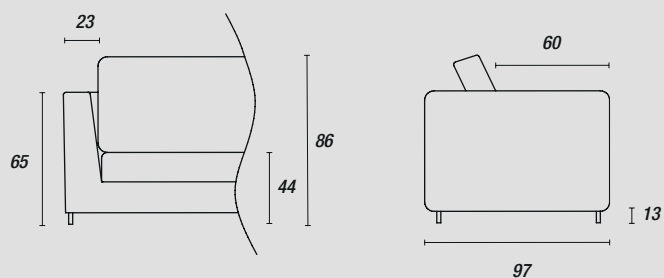

Füße - Piedini:

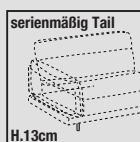

Schwarzes Metall (ME09)
Light brown (ME11)



gegen Aufpreis
Schwarzes Metall (ME09)
Light brown (ME11)

Zubehör - Accessori:

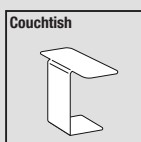

Schwarzes Metall (ME09)
Light brown (ME11)