













Dalton low

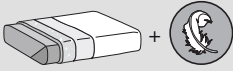

	Seat - Assise	Backrests - Dossiers	Structure - Structure	
Upholstering Revetement (10)	Removable <i>Déhoussable</i>	  	  	
	Not removable <i>Non déhoussable</i>	-	-	 
Padding Rembourrages (2-4-5-6-7-8)	 D.35/40kg/m³	 D.18kg/m³	 +  Polyurethane foam + Tecnoform	 ETHICALLY SOFT MADE optional

TECHNICAL INFORMATION

Structure: 1-3

Supporting structure in class E1 plywood panels and supporting solid fir wood of differing thicknesses, buffers in class E1 particleboard panels.
Structure completely covered with foam and Tecnoform.

Springing: 1-11

Backrest with pre-tensioned elastic strips in propylene fibre and latex.
Seat in class E1 plywood panels.

Note:

With UP feet the whole sofa or composition can be raised 5 cm compared to the dimensions shown.

INFORMATIONS TECHNIQUES

Structure: 1-3

Châssis en panneaux de contreplaqués de classe E1 et supports massifs en épicéa de différentes épaisseurs, compensations en panneaux de fibres de bois de classe E1.
Structure entièrement revêtue de plaques de polyuréthane et Tecnoform

Suspension: 1-11

Dossier en rubans élastiques de fibre propylène et latex mécaniquement pré-tensionnés.
Assise en panneaux de contreplaqué de classe E1.

Note:

Avec les pieds UP tout le canapé ou composition peut être rehaussé de 5 cm par rapport aux dimensions reportées.

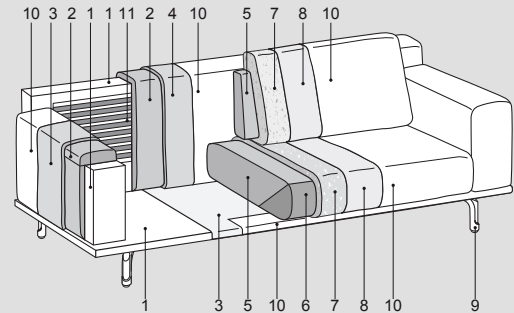
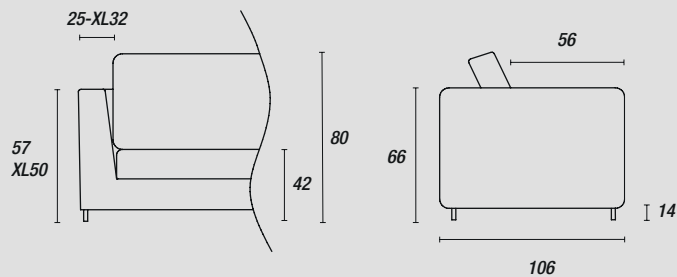

Feet - Pieds::

standard UP



H.14-19cm

Black (ME09)
Light brown (ME11)

optional Dalton

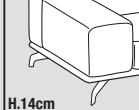

H.14cm

Black (ME09)

optional Dalton

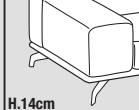

H.14cm

at a surcharge
Shining Chromium (ME04)
Black Chrome (ME05)