

# Krisby



	Seat - Assise	Backrests - Dossiers	Structure - Structure	
<b>Upholstering Revetement (9)</b>	Removable Déhoussable			
	Not removable Non déhoussable	-	-	
<b>Padding Rembourrages (4-5-6-7-8)</b>	+ D.35kg/m³	+ D.21kg/m³	+ Polyurethane foam	 ETHICALLY SOFT MADE optional

## TECHNICAL INFORMATION

### Structure: 1

Structure in solid wood panels, plywood, laminated solid FIR bearing various thicknesses.

### Springing: 1-2

The back is made of multilayered wood or class E1 wood particleboard panels. Seat with pre-tensioned crossed propylene fibre and latex elastic webbing.

## INFORMATIONS TECHNIQUES

### Structure: 1

Structure porteuse en panneau de bois contreplaqué latté et partie massives en sapin de différentes épaisseur.

### Suspension: 1-2

Dossier en panneaux de bois multiplis ou particules de bois en classe E1. Assise en rubans élastique de fibre propylène et latex croisés et mécaniquement pré-tensionnés.

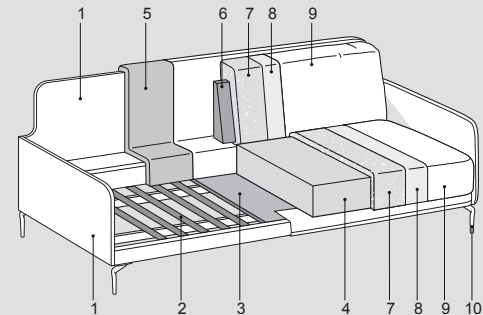
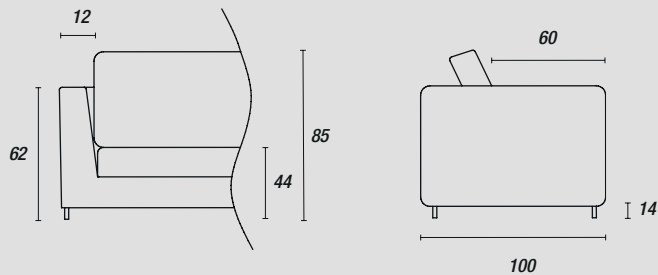

### Feet - Pieds::

#### standard TAG

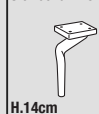

H.14cm  
Black (ME09)  
Light brown (ME11)

#### optional UP

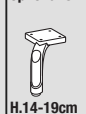

H.14-19cm  
at a surcharge  
Black (ME09)  
Light brown (ME11)

#### optional Bjorg

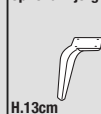

H.13cm  
Black (ME09)  
Light brown (ME11)  
Anthracite (ME01)  
Dark brown (ME03)

#### optional Bjorg

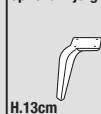

H.13cm  
at a surcharge  
Shining Chromium (ME04)  
Black Chrome (ME05)





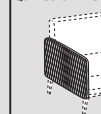

### Accessories - Accessoires:

#### Quilted armrest

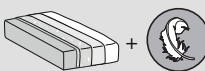

# Krisby mix



	Seat - Assise	Backrests - Dossiers	Structure - Structure	
<b>Upholstering</b> <b>Revetement</b> <b>(9)</b>	Removable <i>Déhoussable</i>			-
	Not removable <i>Non déhoussable</i>	-	-	
<b>Padding</b> <b>Rembourrages</b> <b>(4-5-6-7-8)</b>	 D.35kg/m³	 D.21kg/m³	 Polyurethane foam	 optional

## TECHNICAL INFORMATION

### Structure: 1

Structure in solid wood panels, plywood, laminated solid FIR bearing various thicknesses.

### Springing: 1-2

The back is made of multilayered wood or class E1 wood particleboard panels. Seat with pre-tensioned crossed propylene fibre and latex elastic webbing.

### Note:

Base covered with Soft leather; for articles upholstered with leather parts from other categories, consider the indicated surcharge. Tone on tone edge as a standard, if contrasting, specify the color.

## INFORMATIONS TECHNIQUES

### Structure: 1

Structure porteuse en panneau de bois contreplaqué latté et partie massives en sapin de différentes épaisseur.

### Suspension: 1-2

Dossier en panneaux de bois multiplis ou particules de bois en classe E1. Assise en rubans élastique de fibre propylène et latex croisés et mécaniquement pré-tensionnés.

### Note:

Structure revetue en cuir cat. Soft; pour l'article rembourré avec des parties dans d'autres catégories de cuir, rajouter la majoration qui est indiquée. Bordure de série ton sur ton, préciser la couleur si contraste.

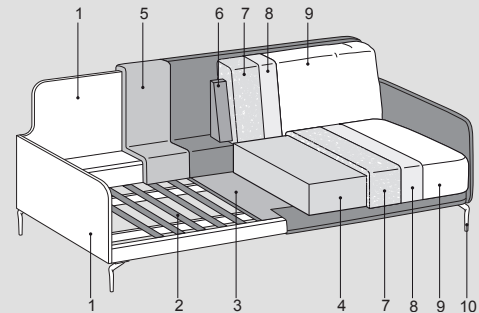
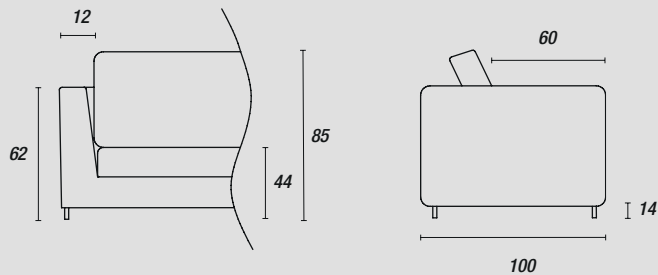

### Feet - Pieds::

#### standard TAG

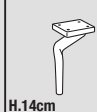

H.14cm  
Black (ME09)  
Light brown (ME11)

#### optional UP

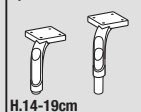

H.14-19cm  
at a surcharge  
Black (ME09)  
Light brown (ME11)

#### optional Bjorg



H.13cm  
Black (ME09)  
Light brown (ME11)  
Anthracite (ME01)  
Dark brown (ME03)

#### optional Bjorg



H.13cm  
at a surcharge  
Shining Chromium (ME04)  
Black Chrome (ME05)

### Accessories - Accessoires:

#### Quilted armrest

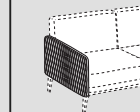

# Krisby low



	Seat - Assise	Backrests - Dossiers	Structure - Structure	
<b>Upholstering</b> <i>Revetement</i> (9)	Removable <i>Déhoussable</i>			
	Not removable <i>Non déhoussable</i>	-	-	
<b>Padding</b> <i>Rembourrages</i> (4-5-6-7-8)	+ D.35kg/m³	+ D.21kg/m³	+ Polyurethane foam	 ETHICALLY SOFT MADE optional

## TECHNICAL INFORMATION

### Structure: 1

Structure in solid wood panels, plywood, laminated solid FIR bearing various thicknesses.

### Springing: 1-2

The back is made of multilayered wood or class E1 wood particleboard panels. Seat with pre-tensioned crossed propylene fibre and latex elastic webbing.

## INFORMATIONS TECHNIQUES

### Structure: 1

Structure porteuse en panneau de bois contreplaqué latté et partie massives en sapin de différentes épaisseur.

### Suspension: 1-2

Dossier en panneaux de bois multiplis ou particules de bois en classe E1. Assise en rubans élastique de fibre propylène et latex croisés et mécaniquement pré-tensionnés.

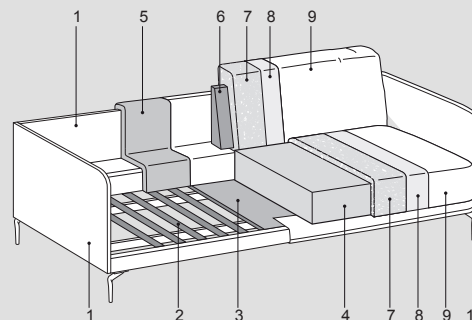
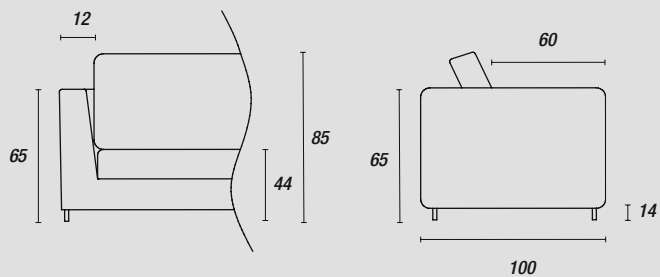

### Feet - Pieds::

#### standard TAG

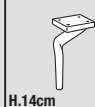

H.14cm  
Black (ME09)  
Light brown (ME11)

#### optional UP



H.14-19cm  
at a surcharge  
Black (ME09)  
Light brown (ME11)

#### optional Bjorg

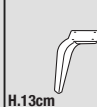

H.13cm  
Black (ME09)  
Light brown (ME11)  
Anthracite (ME01)  
Dark brown (ME03)

#### optional Bjorg

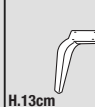

H.13cm  
at a surcharge  
Shining Chromium (ME04)  
Black Chrome (ME05)





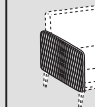

### Accessories - Accessoires:

#### Quilted armrest

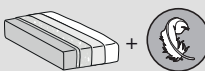

# Krisby mix low



	Seat - Assise	Backrests - Dossiers	Structure - Structure	
<b>Upholstering</b> <i>Revetement</i> (9)	Removable <i>Déhoussable</i>			-
	Not removable <i>Non déhoussable</i>	-	-	-
<b>Padding</b> <i>Rembourrages</i> (4-5-6-7-8)	 D.35kg/m³	 D.21kg/m³	 Polyurethane foam	 optional

## TECHNICAL INFORMATION

### Structure: 1

Structure in solid wood panels, plywood, laminated solid FIR bearing various thicknesses.

### Springing: 1-2

The back is made of multilayered wood or class E1 wood particleboard panels. Seat with pre-tensioned crossed propylene fibre and latex elastic webbing.

### Note:

Base covered with Soft leather; for articles upholstered with leather parts from other categories, consider the indicated surcharge. Tone on tone edge as a standard, if contrasting, specify the color.

## INFORMATIONS TECHNIQUES

### Structure: 1

Structure porteuse en panneau de bois contreplaqué latté et partie massives en sapin de différentes épaisseur.

### Suspension: 1-2

Dossier en panneaux de bois multiplis ou particules de bois en classe E1. Assise en rubans élastique de fibre propylène et latex croisés et mécaniquement pré-tensionnés.

### Note:

Structure revêtue en cuir cat. Soft; pour l'article rembourré avec des parties dans d'autres catégories de cuir, rajouter la majoration qui est indiquée. Bordure de série ton sur ton, préciser la couleur si contraste.

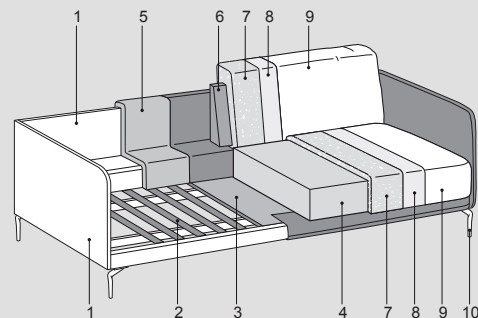
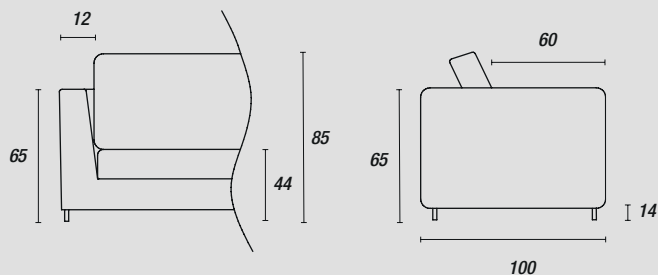

### Feet - Pieds::

#### standard TAG

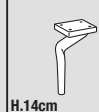

H.14cm  
Black (ME09)  
Light brown (ME11)

#### optional UP

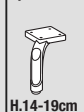

H.14-19cm  
at a surcharge  
Black (ME09)  
Light brown (ME11)

#### optional Bjorg

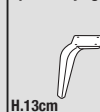

H.13cm  
Black (ME09)  
Light brown (ME11)  
Anthracite (ME01)  
Dark brown (ME03)

#### optional Bjorg

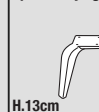

H.13cm  
at a surcharge  
Shining Chromium (ME04)  
Black Chrome (ME05)

### Accessories - Accessoires:

#### Quilted armrest

