

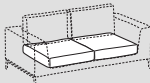

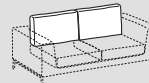

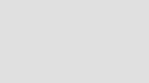





Clip

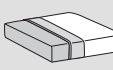

	 Seduta - Seat	 Schienali - Backrests	-	 Pouff - Footstool
Rivestimento Upholstering (6) Sfoderabile Removable	—	—		
Non sfoderabile Not removable	 	 		
Imbottiture Padding (3-4-5)	 +  D.30kg/m ³	 +  lastre D.25kg/m ³		

INFORMAZIONI TECNICHE

Struttura: 1

Struttura portante in pannelli di legno multistrato e masselli portanti in abete di vari spessori, tamponamenti in pannelli di particelle di legno in classe E1.

Molleggio: 2

Schienale in pannelli di fibra di legno dura o cellulosa. Seduta in nastri elastici di fibra propilenica e lattice incrociati e meccanicamente pretensionati.

Note:

Per divani e poltrona basamento opzionale in legno. Basamento girevole della poltrona swivel in metallo. Panca con piano e piedini in metallo verniciato, tavolini in metallo verniciato.

TECHNICAL INFORMATION

Structure: 1

Supporting structure of plywood and pinewood with parts of E1 class agglomeration panels or cellulose agglomeration panels.

Springing: 2

The back is made of hard or cellulose wooden fibre panels. Seat with pre-tensioned crossed propylene fibre and latex elastic webbing.

Note:

Optional wooden base for sofas and armchair. Metal rotating base for swivel armchair. Bench with laquered metal top and feet, laquered metal small tables.

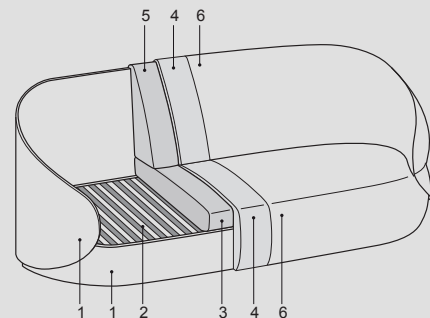
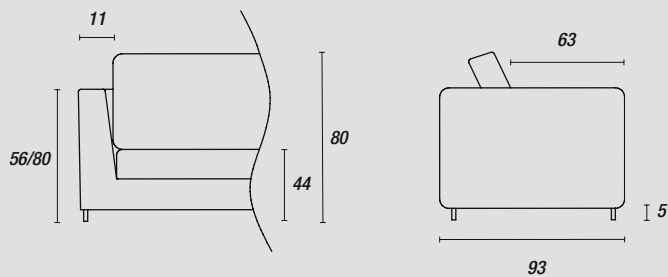

Piedini - Feet:

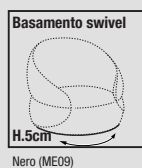
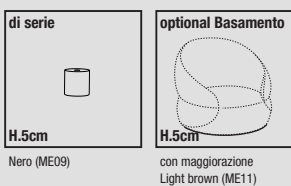

Accessori - Accessories:

