

# Krisby



	Seduta - Seat	Schienali - Backrests	Struttura - Structure	
<b>Rivestimento Upholstering (9)</b>	Sfoderabile Removable Non sfoderabile Not removable	Sfoderabile Removable Non sfoderabile Not removable	Sfoderabile Removable Non sfoderabile Not removable	
<b>Imbottiture Padding (4-5-6-7-8)</b>	D.35kg/m³	D.21kg/m³	Pol.espanso	<b>ECOSY</b> ETHICALLY SOFT MADE Optional

## INFORMAZIONI TECNICHE

### Struttura: 1

Struttura portante in pannelli di legno listellare multistrato e masselli portanti in abete di vari spessori.

### Molleggio: 1-2

Schienale in pannello in multistrati di legno o di particelle di legno in classe E1. Seduta in nastri elastici di fibra propilenica e lattice incrociati e meccanicamente pretensionati.

## TECHNICAL INFORMATION

### Structure: 1

Structure in solid wood panels, plywood, laminated solid FIR bearing various thicknesses.

### Springing: 1-2

The back is made of multilayered wood or class E1 wood particleboard panels. Seat with pre-tensioned crossed propylene fibre and latex elastic webbing.

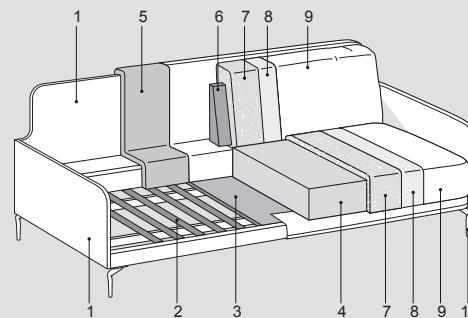
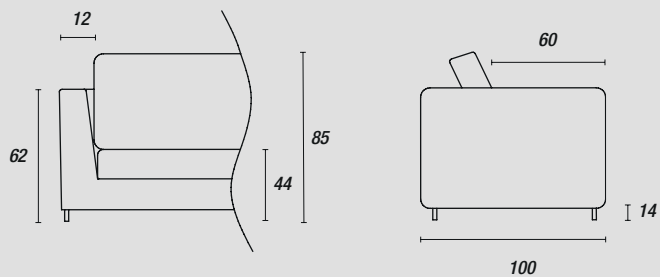

### Piedini - Feet:

#### di serie Tag

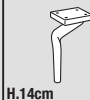

H.14cm

Nero (ME09)  
Light brown (ME11)

#### optional Up



H.14-19cm

con maggiorazione  
Nero (ME09)  
Light brown (ME11)

#### optional Bjorg

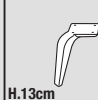

H.13cm

Nero (ME09)  
Light brown (ME11)  
Antracite (ME01)  
Testa di moro (ME03)

#### optional Bjorg

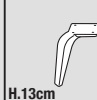

H.13cm

con maggiorazione  
Cromo lucido (ME04)  
Cromo nero (ME05)





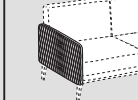

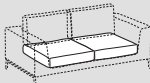
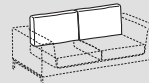
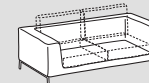

### Accessori - Accessories:

#### Bracciolo trapuntato

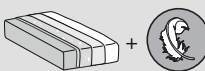

# Krisby mix

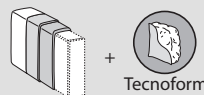

	 Seduta - Seat	 Schienali - Backrests	 Struttura - Structure	
<b>Rivestimento Upholstering (9)</b>	Sfoderabile Removable 	Sfoderabile Removable 	-	
	Non sfoderabile Not removable -	Non sfoderabile Not removable -		
<b>Imbottiture Padding (4-5-6-7-8)</b>	 D.35kg/m³	 D.21kg/m³	 Pol.espanso Tecnoform	 Optional

## INFORMAZIONI TECNICHE

### Struttura: 1

Struttura portante in pannelli di legno listellare multistrato e masselli portanti in abete di vari spessori.

### Molleggio: 1-2

Schienale in pannello in multistrati di legno o di particelle di legno in classe E1. Seduta in nastri elastici di fibra propilenica e lattice incrociati e meccanicamente pretensionati.

### Note:

Scocca rivestita in pelle Cat. Soft; per articolo imbottito con parti in pelle di altre categorie, aggiungere la maggiorazione indicata. Bordo di serie tono su tono, se in contrasto specificare il colore.

## TECHNICAL INFORMATION

### Structure: 1

Structure in solid wood panels, plywood, laminated solid FIR bearing various thicknesses.

### Springing: 1-2

The back is made of multilayered wood or class E1 wood particleboard panels. Seat with pre-tensioned crossed propylene fibre and latex elastic webbing.

### Note:

Base covered with Soft leather; for articles upholstered with leather parts from other categories, consider the indicated surcharge. Tone on tone edge as a standard, if contrasting, specify the color.

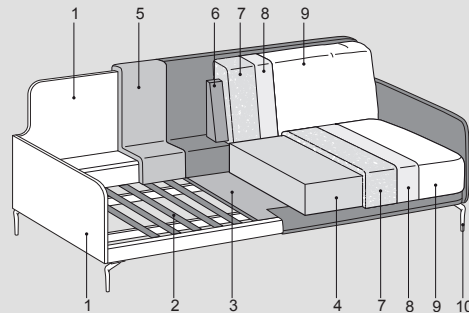
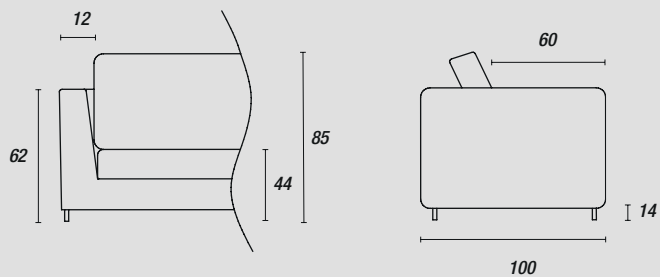

### Piedini - Feet:

#### di serie Tag

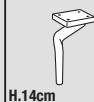

H.14cm

Nero (ME09)  
Light brown (ME11)

#### optional Up



H.14-19cm

con maggiorazione  
Nero (ME09)  
Light brown (ME11)

#### optional Bjorg

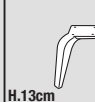

H.13cm

Nero (ME09)  
Light brown (ME11)  
Antracite (ME01)  
Testa di moro (ME03)

#### optional Bjorg

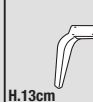

H.13cm

con maggiorazione  
Cromo lucido (ME04)  
Cromo nero (ME05)

### Accessori - Accessories:

#### Bracciolo trapuntato

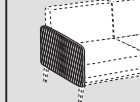

# Krisby low



	Seduta - Seat	Schienali - Backrests	Struttura - Structure	
<b>Rivestimento Upholstering (9)</b>	Sfoderabile / Removable Non sfoderabile / Not removable	Sfoderabile / Removable Non sfoderabile / Not removable	Sfoderabile / Removable Non sfoderabile / Not removable	
<b>Imbottiture Padding (4-5-6-7-8)</b>	D.35kg/m³	D.21kg/m³	Pol.espanso Tecnoform	<b>ECOSY</b> ETHICALLY SOFT MADE Optional

## INFORMAZIONI TECNICHE

### Struttura: 1

Struttura portante in pannelli di legno listellare multistrato e masselli portanti in abete di vari spessori.

### Molleggio: 1-2

Schienale in pannello in multistrati di legno o di particelle di legno in classe E1. Seduta in nastri elastici di fibra propilenica e lattice incrociati e meccanicamente pretensionati.

## TECHNICAL INFORMATION

### Structure: 1

Structure in solid wood panels, plywood, laminated solid FIR bearing various thicknesses.

### Springing: 1-2

The back is made of multilayered wood or class E1 wood particleboard panels. Seat with pre-tensioned crossed propylene fibre and latex elastic webbing.

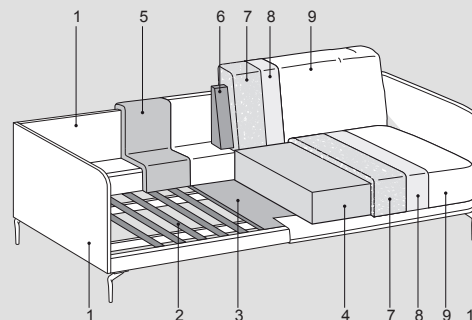
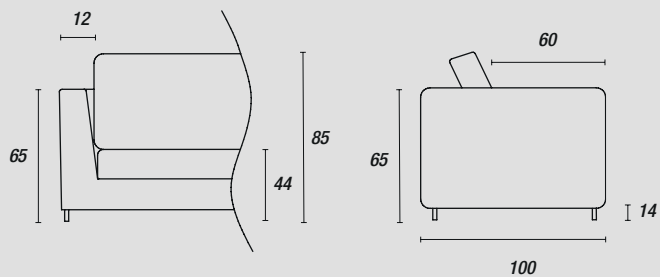

### Piedini - Feet:

#### di serie Tag

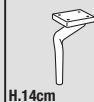

H.14cm

Nero (ME09)  
Light brown (ME11)

#### optional Up



H.14-19cm

con maggiorazione  
Nero (ME09)  
Light brown (ME11)

#### optional Bjorg

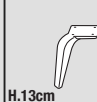

H.13cm

Nero (ME09)  
Light brown (ME11)  
Antracite (ME01)  
Testa di moro (ME03)

#### optional Bjorg

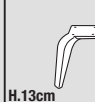

H.13cm

con maggiorazione  
Cromo lucido (ME04)  
Cromo nero (ME05)

### Accessori - Accessories:



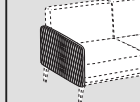



#### Bracciolo trapuntato



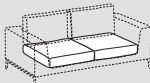
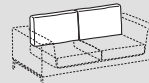
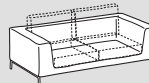

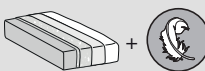
# Krisby mix low



	 Seduta - Seat	 Schienali - Backrests	 Struttura - Structure	
<b>Rivestimento Upholstering (9)</b>	Sfoderabile Removable 	Sfoderabile Removable 	-	
	Non sfoderabile Not removable -	Non sfoderabile Not removable -	-	
<b>Imbottiture Padding (4-5-6-7-8)</b>	 D.35kg/m³	 D.21kg/m³	 Pol.espanso Tecnoform	 Optional

## INFORMAZIONI TECNICHE

### Struttura: 1

Struttura portante in pannelli di legno listellare multistrato e masselli portanti in abete di vari spessori.

### Molleggio: 1-2

Schienale in pannello in multistrati di legno o di particelle di legno in classe E1. Seduta in nastri elastici di fibra propilenica e lattice incrociati e meccanicamente pretensionati.

### Note:

Scocca rivestita in pelle Cat. Soft; per articolo imbottito con parti in pelle di altre categorie, aggiungere la maggiorazione indicata. Bordo di serie tono su tono, se in contrasto specificare il colore.

## TECHNICAL INFORMATION

### Structure: 1

Structure in solid wood panels, plywood, laminated solid FIR bearing various thicknesses.

### Springing: 1-2

The back is made of multilayered wood or class E1 wood particleboard panels. Seat with pre-tensioned crossed propylene fibre and latex elastic webbing.

### Note:

Base covered with Soft leather; for articles upholstered with leather parts from other categories, consider the indicated surcharge. Tone on tone edge as a standard, if contrasting, specify the color.

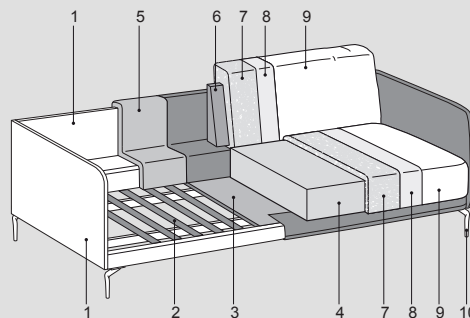
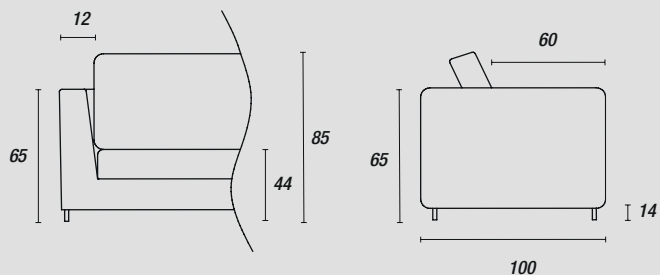

### Piedini - Feet:

#### di serie Tag

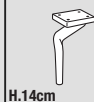

H.14cm  
Nero (ME09)  
Light brown (ME11)

#### optional Up



H.14-19cm  
con maggiorazione  
Nero (ME09)  
Light brown (ME11)

#### optional Bjorg

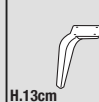

H.13cm  
Nero (ME09)  
Light brown (ME11)  
Antracite (ME01)  
Testa di moro (ME03)

#### optional Bjorg



H.13cm  
con maggiorazione  
Cromo lucido (ME04)  
Cromo nero (ME05)

### Accessori - Accessories:

#### Bracciolo trapuntato

