

# Skin



	Seduta - Seat	Schienali - Backrests	Base - Base	
<b>Rivestimento Upholstering (11)</b>	Sfoderabile Removable	Sfoderabile Removable	Sfoderabile Removable	
	Non sfoderabile Not removable	Non sfoderabile Not removable	Non sfoderabile Not removable	
<b>Imbottiture Padding (4-5-6-7-8-9-10)</b>	 D.35/40kg/m³ memory foam & Tecnoform	 D.25kg/m³	 Accoppiato	 Optional

## INFORMAZIONI TECNICHE

### Struttura: 1-2

Struttura portante in pannelli di legno multistrato in classe E1, masselli in legno di abete e faggio di vari spessori. Fianchi di tamponamento in pannelli di legno multistrati e particelle di legno in classe E1, particolari in pannelli di fibra di legno dura o cellulosa. Bracciolo in legno multistrato curvato.

### Molleggio: 1-3

Schienale in nastri elastici di fibra propilenica e lattice meccanicamente pretensionati. Seduta in nastri elastici di fibra propilenica e lattice incrociati e meccanicamente pretensionati.

### Note:

Pannello bracciolo non sfoderabile.  
Tavolino Skin in metallo verniciato.

## TECHNICAL INFORMATION

### Structure: 1-2

Supporting frame in class E1 plywood panels, solid spruce and beech wood supports in various thicknesses. Buffer sides in grade E1 plywood and particleboard panels; details in hardwood or cellulose fibreboard panels. Curved plywood armrest.

### Springing: 1-3

Backrest with pre-tensioned elastic strips in propylene fibre and latex. Seat with pre-tensioned crossed propylene fibre and latex elastic webbing.

### Note:

Armrest panel cover non removable  
Metal varnished Skin small table

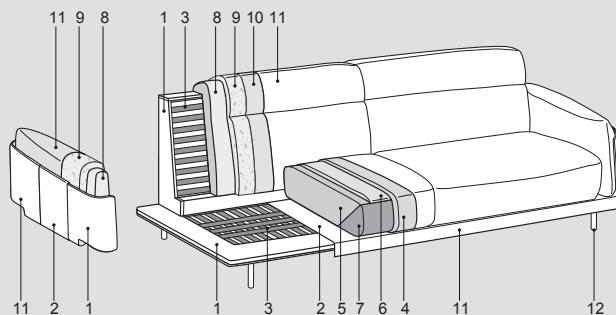
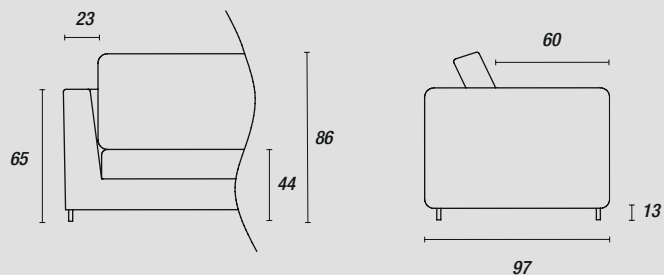

### Piedini - Feet:

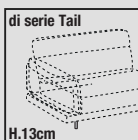

Nero (ME09)  
Light brown (ME11)



con maggiorazione  
Nero (ME09)  
Light brown (ME11)

### Accessori - Accessories:

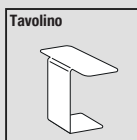



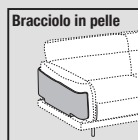



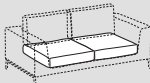
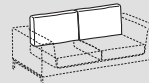
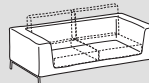

Nero (ME09)  
Light brown (ME11)

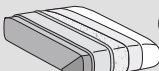

# Skin mix



	 Seduta - Seat	 Schienali - Backrests	 Base - Base	
<b>Rivestimento Upholstering (11)</b>	Sfoderabile Removable 	Sfoderabile Removable 	—	
	Non sfoderabile Not removable —	—		
<b>Imbottiture Padding (4-5-6-7-8-9-10)</b>	 D.35/40kg/m³ memory foam & Tecnoform	 D.25kg/m³	 Accoppiato	 Optional

## INFORMAZIONI TECNICHE

### Struttura: 1-2

Struttura portante in pannelli di legno multistrato in classe E1, masselli in legno di abete e faggio di vari spessori. Fianchi di tamponamento in pannelli di legno multistrati e particelle di legno in classe E1, particolari in pannelli di fibra di legno dura o cellulosa. Bracciolo in legno multistrato curvato.

### Molleggio: 1-3

Schienale in nastri elastici di fibra propilenica e lattice meccanicamente pretensionati. Seduta in nastri elastici di fibra propilenica e lattice incrociati e meccanicamente pretensionati.

### Note:

Pannello bracciolo non sfoderabile.  
Tavolino Skin in metallo verniciato.

## TECHNICAL INFORMATION

### Structure: 1-2

Supporting frame in class E1 plywood panels, solid spruce and beech wood supports in various thicknesses. Buffer sides in grade E1 plywood and particleboard panels; details in hardwood or cellulose fibreboard panels. Curved plywood armrest.

### Springing: 1-3

Backrest with pre-tensioned elastic strips in propylene fibre and latex. Seat with pre-tensioned crossed propylene fibre and latex elastic webbing.

### Note:

Armrest panel cover non removable  
Metal varnished Skin small table

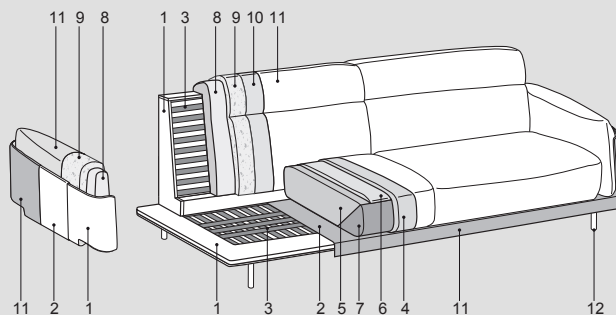
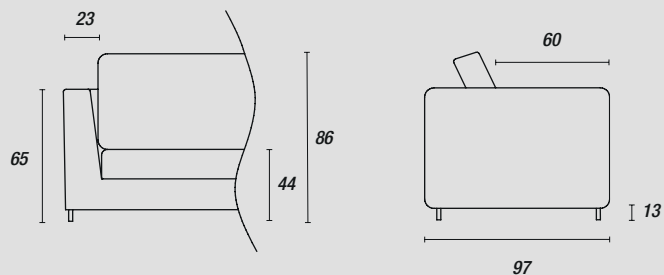

### Piedini - Feet:

#### di serie Tail

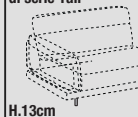

Nero (ME09)  
Light brown (ME11)

#### optional slitta Skin



con maggiorazione  
Nero (ME09)  
Light brown (ME11)

### Accessori - Accessories:

#### Tavolino



Nero (ME09)  
Light brown (ME11)