













Bepop

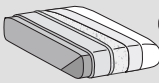

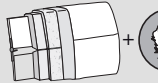
	Sitzkissen - <i>Seduta</i>	Rückenkissen - <i>Schienali</i>	Gestell - <i>Struttura</i>	
Bezug: Rivestimento (11)	abziehbar <i>Sfoderabile</i>			
	 			
	nicht abziehbar <i>Non sfoderabile</i>			
	—			
Polsterungen Imbottiture (4-5-6-7-8-9-10)	   D.35/40kg/m³	  D.21kg/m³	  Polyurethanschaumstoff	 optional

TECHNISCHE BESCHREIBUNG

Gestell: 1-2

Massivholzträger aus Fichten- und Buchenholz in verschiedenen Stärken. Seitliche Verblendung aus Mehrschichtholzplatten und Spanplatten der Klasse E1, Details aus Hartholzfaser oder Zelluloseplatten.

Federung: 1-3

Rückenlehne aus harten Holzfasern oder Zellulose.

Sitz in gekreuzten und mechanisch vorgespannten elastischen Bändern aus Propylenfaser und Latex.

Hinweis

Kopfstütze Mechanismus (12) in verchromtem Stahl in 6 Positionen mit manuellem Mechanismus verstellbar.

INFORMAZIONI TECNICHE

Struttura: 1-2

Masselli portanti in legno di abete e faggio di vari spessori. Fianchi di tamponamento in pannelli di legno multistrati e particelle di legno in classe E1, particolari in pannelli di fibra di legno dura o cellulosa.

Molleggio: 1-3

Schienale in pannelli di fibra di legno dura o cellulosa.

Seduta in nastri elastici di fibra propilenica e lattice incrociati e meccanicamente pretensionati.

Note:

Meccanismo del poggiatesta (12) in acciaio cromato regolabile in 6 posizioni con meccanismo manuale.

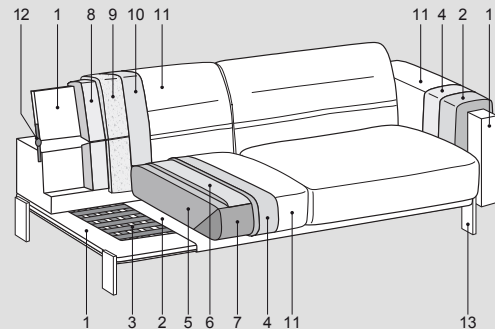
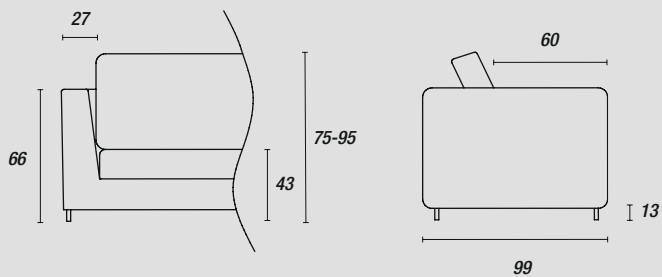

Füße - Piedini:

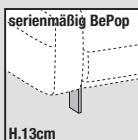

Schwarzes Metall (ME09)
Light brown (ME11)