













# Blake high

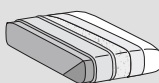

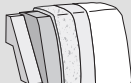
	Sitzkissen - <i>Seduta</i>	Rückenkissen - <i>Schienali</i>	Gestell - <i>Struttura</i>	
<b>Bezug:</b> <b>Rivestimento</b> (12)	abziehbar <i>Sfoderabile</i>			
	 			
	nicht abziehbar <i>Non sfoderabile</i>			
	—			
<b>Polsterungen</b> <b>Imbottiture</b> (4-5-6-7-8-9-10-11)	   D.35/50kg/m <sup>3</sup>	 +  D.25/30kg/m <sup>3</sup>	 +  Polyurethanschaumstoff	 ETHICALLY SOFT MADE optional

## TECHNISCHE BESCHREIBUNG

### Gestell: 1-2

Massivholzträger aus Fichten- und Buchenholz in verschiedenen Stärken. Seitliche Verblendung aus Mehrschichtholzplatten und Spanplatten der Klasse E1, Details aus Hartholzfaser oder Zelluloseplatten.

### Federung: 3

Rückenlehne aus mechanisch vorgespannten Propylenfaser- und Latex-Elastikgurten. Sitz in gekreuzten und mechanisch vorgespannten elastischen Bändern aus Propylenfaser und Latex.

### Hinweis

Modulare Elemente, die mit Elementen des Blake Low-Modells kombiniert werden können.

## INFORMAZIONI TECNICHE

### Struttura: 1-2

Masselli portanti in legno di abete e faggio di vari spessori. Fianchi di tamponamento in pannelli di legno multistrati e particelle di legno in classe E1, particolari in pannelli di fibra di legno dura o cellulosa.

### Molleggio: 3

Schienale in nastri elastici di fibra propilenica e lattice meccanicamente pretensionati. Seduta in nastri elastici di fibra propilenica e lattice incrociati e meccanicamente pretensionati.

### Note:

Articoli componibili abbinabili ad elementi del modello Blake low.

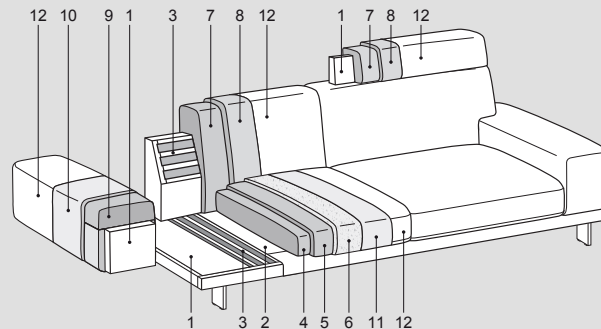
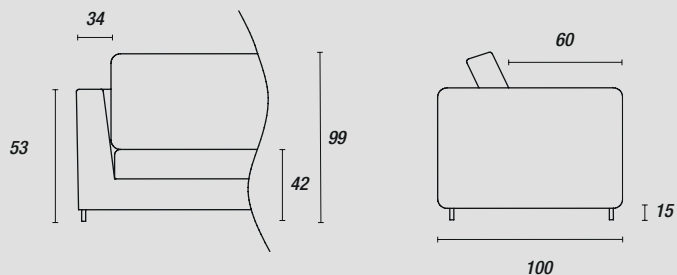

### Füße - Piedini:

#### serienmäßig Browse



H.15cm

Schwarzes Metall (ME09)  
Light brown (ME11)

#### optional Hulu



H.15cm

Schwarzes Metall (ME09)  
Light brown (ME11)

# Blake low



	Sitzkissen - <i>Seduta</i>	Rückenkissen - <i>Schienali</i>	Gestell - <i>Struttura</i>	
<b>Bezug:</b> <b>Rivestimento</b> (12)	abziehbar <i>Sfoderabile</i>	abziehbar <i>Sfoderabile</i>	abziehbar <i>Sfoderabile</i>	
	nicht abziehbar <i>Non sfoderabile</i>	nicht abziehbar <i>Non sfoderabile</i>	nicht abziehbar <i>Non sfoderabile</i>	
<b>Polsterungen</b> <b>Imbottiture</b> (4-5-6-7-8-9-10-11)	 D.35/50kg/m <sup>3</sup>	 D.25/30kg/m <sup>3</sup>	 Polyurethanschaumstoff	 ETHICALLY SOFT MADE optional

## TECHNISCHE BESCHREIBUNG

### Gestell: 1-2

Massivholzträger aus Fichten- und Buchenholz in verschiedenen Stärken. Seitliche Verblendung aus Mehrschichtholzplatten und Spanplatten der Klasse E1, Details aus Hartholzfaser oder Zelluloseplatten.

### Federung: 3

Rückenlehne aus harten Holzfasern oder Zellulose.

Sitz in gekreuzten und mechanisch vorgespannten elastischen Bändern aus Propylenfaser und Latex.

### Hinweis

Modulare Elemente, die mit Elementen des Blake High-Modells kombiniert werden können.

Tische aus Holzspanplatten der Klasse E1 furniert. Zubehör für Metalltisch mit regeneriertem Leder bezogen.

## INFORMAZIONI TECNICHE

### Struttura: 1-2

Masselli portanti in legno di abete e faggio di vari spessori. Fianchi di tamponamento in pannelli di legno multistrati e particelle di legno in classe E1, particolari in pannelli di fibra di legno dura o cellulosa.

### Molleggio: 3

Schienale in pannelli di fibra di legno dura o cellulosa.

Seduta in nastri elastici di fibra propilenica e lattice incrociati e meccanicamente pretensionati.

### Note:

Articoli componibili abbinabili ad elementi del modello Blake high.

Tavolini in pannelli di particelle di legno in classe E1 impiallacciati. Accessorio per tavolino in metallo rivestito in rigenerato di cuoio.

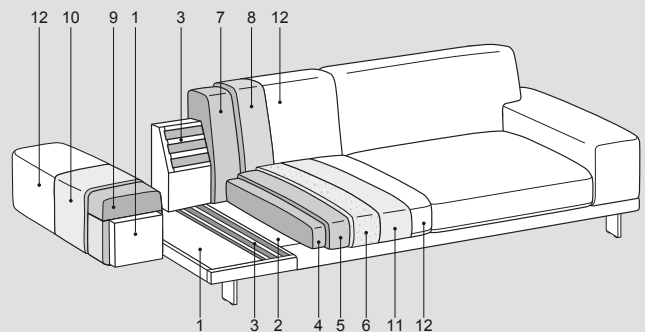
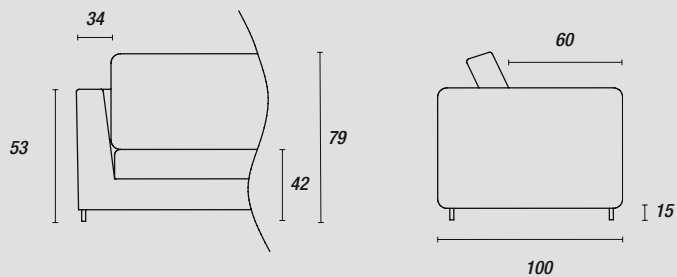

### Füße - Piedini:

#### serienmäßig Browse



Schwarzes Metall (ME09)  
Light brown (ME11)

#### optional Hulu



Schwarzes Metall (ME09)  
Light brown (ME11)

### Zubehör - Accessori:

#### Couchtish



Walnuß chocolate  
Grey wood (LE12)

#### Zubehör



Anthrazit (CR06)  
Hanf (CR10)