







 Sitzkissen - <i>Seduta</i>	 Rückenkissen - <i>Schienale</i>	
Bezug: Rivestimento (8)	abziehbar <i>Sfoderabile</i> —	abziehbar <i>Sfoderabile</i> —	
	nicht abziehbar <i>Non sfoderabile</i>  	nicht abziehbar <i>Non sfoderabile</i>  	
Polsterungen Imbottiture (3-5-6-7)	 +  D.30/35kg/m ³	 +  D.30/35kg/m ³	

TECHNISCHE BESCHREIBUNG

Gestell: 1-2

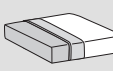
Tragkonstruktion aus Mehrschichttischlerplatten und Massivholzträgern aus Fichtenholz in verschiedenen Stärken, Füllungen aus Hartholzfaser oder Zelluloseplatten.

Federung: 2-4

Rückenlehne aus harten Holzfasern oder Zellulose.
Sitzfläche mit elastischen Gurten aus Propylenfaser und Latex.

Hinweis

Mittelfuß aus transparentem Methacrylat.

INFORMAZIONI TECNICHE

Struttura: 1-2

Struttura portante in pannelli multistrato di legno e masselli in abete di vari spessori, tamponamenti in pannelli di fibra di legno dura o cellulosa.

Molleggio: 2-4

Schienale in pannello di fibra di legno dura o cellulosa.
Seduta in nastri elastici di fibra propilenica e lattice.

Note:

Piedino centrale in metacrilato trasparente.

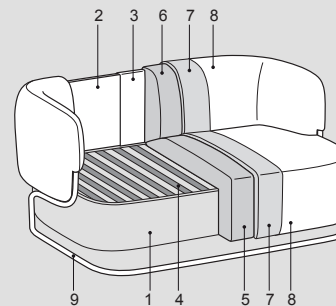
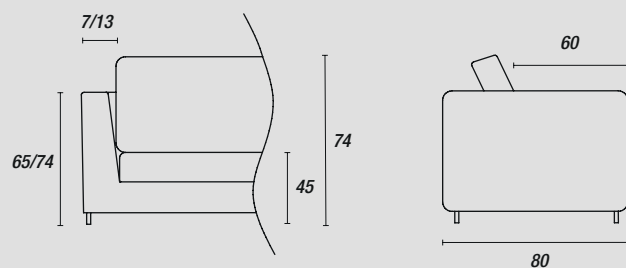

Gestell - Basamento:

serienmäßig



Schwarzes Metall (ME09)
Light brown (ME11)