









 Seduta - Seat	 Schienale - Backrest		
<b>Rivestimento</b> <b>Upholstering</b> <b>(8)</b>	Sfoderabile Removable —	Sfoderabile Removable —		
	Non sfoderabile Not removable   	Non sfoderabile Not removable   		
<b>Imbottiture</b> <b>Padding</b> <b>(3-5-6-7)</b>	 +  Tecnoform D.30/35kg/m <sup>3</sup>	 +  Tecnoform D.30/35kg/m <sup>3</sup>		

## INFORMAZIONI TECNICHE

### Struttura: 1-2

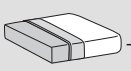
Masselli portanti in legno di abete. Elementi strutturali in pannelli di legno multistrati in classe E1, tamponamenti in faesite.

### Molleggio: 2-4

Schienale in pannello di faesite. Seduta in nastri elastici di fibra propilenica e lattice incrociati e meccanicamente pretensionati.

### Note:

Piedino centrale in metacrilato trasparente.

## TECHNICAL INFORMATION

### Structure: 1-2

Solid fir wood. Structural elements in multilayer wood panels in class E1, infills in faesite.

### Springing: 2-4

The back is made of hardboard panels. Seat with pre-tensioned crossed propylene fibre and latex elastic webbing.

### Note:

Central foot in transparent methacrylate.

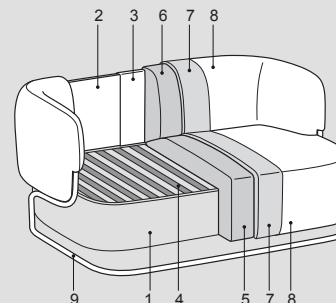
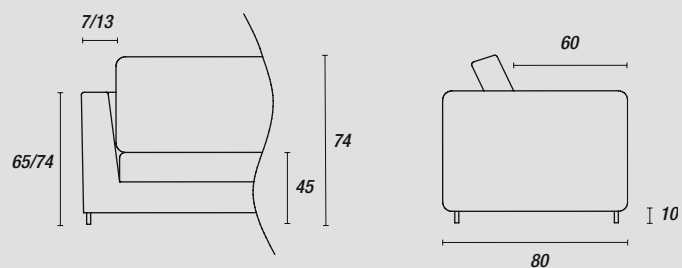

## Basamento - Base:

di serie



Nero (ME09)  
Light brown (ME11)