

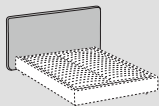

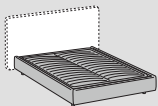







Clip



| |  Testiera - Headboard |  Giroletto - Bed frame | | |
|---|--|--|--|--|
| Rivestimento Upholstering (7) Sfoderabile <i>Removable</i> | — |    | | |
| Non sfoderabile <i>Not removable</i> |    | — | | |
| Imbottiture Padding (3-4-5-6) |  +  D.21/30kg/m³ |  +  D.30kg/m³ | | |

INFORMAZIONI TECNICHE

Struttura: (1-2)

Elementi della testiera in pannelli di legno multistrato curvati, longoni e pediera in pannelli di particelle di legno (MDF) in classe E1.

Note:

Possibilità di regolare l'altezza della rete su cui appoggia il materasso.

Caratteristiche relative ai materiali utilizzati descritte nella sezione tecnica a fine listino. Coprirete disponibile nella sezione accessori per letti.

TECHNICAL INFORMATION

Structure: (1-2)

Headboard elements in E1 class multilayer wood panels, bed sides and footboard in multilayer wood panels (MDF) in class E1.

Note:

Height-adjustment option for the bedbase that supports the mattress, allowing total or partial integration.

For characteristics of the used materials, see the technical section. Bed-base cover set available in the section "Bed accessories"

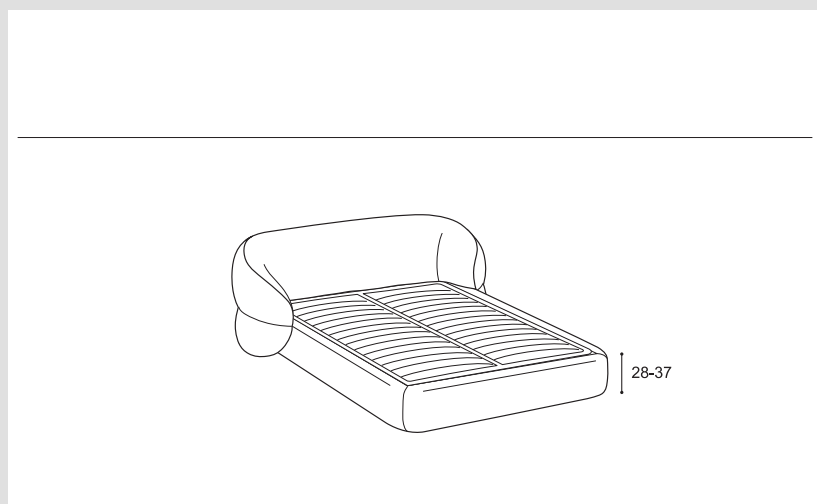
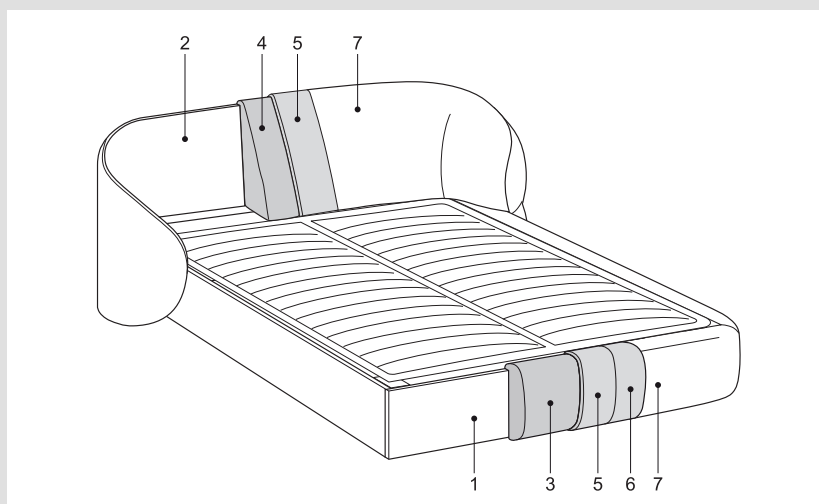

Disponibile per materasso da:
 Available for mattress:

