

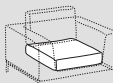

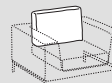

356 outdoor Verflechtung

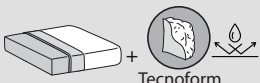

	 Sitzkissen - <i>Seduta</i>	 Rückenkissen - <i>Schienale</i>	
Bezug: Rivestimento (8)	abziehbar <i>Sfoderabile</i>		
	nicht abziehbar <i>Non sfoderabile</i>	—	—
Polsterungen Imbottiture (5-6-7)	 D.30kg/m³	 D.18kg/m³	

TECHNISCHE BESCHREIBUNG

Gestell: 1-2-3

Struktur aus mehrschichtigen Tischlerplatten und Massivholzplatten mit Okume in verschiedenen Stärken.

Federung: 2-3-4

Rohrförmige Rückenlehne aus lackiertem Metall mit Outdoor-Behandlung und geflochtenem Seil.

Sitzfläche mit elastischen Gurten aus Propylenfaser und Latex.

Hinweis

Vorbezug aus atmungsaktivem, wasserabweisendem Material.
Heißversiegelter wasserabweisender Bezug auf Anfrage erhältlich (technische Daten siehe Seite Materialien, Oberflächen und Warnhinweise).

INFORMAZIONI TECNICHE

Struttura: 1-2-3

Struttura in pannelli di legno listellare multistrato e masselli portanti in okume' di vari spessori.

Molleggio: 2-3-4

Schienale tubolare in metallo verniciato con trattamento outdoor e corda intrecciata.

Seduta in nastri elastici di fibra propilenica e lattice.

Note:

Prefodera in materiale idrorepellente traspirante.

Disponibile a richiesta cover idrorepellente termosaldada (per specifiche tecniche vedi pagina materiali, finiture e avvertenze).

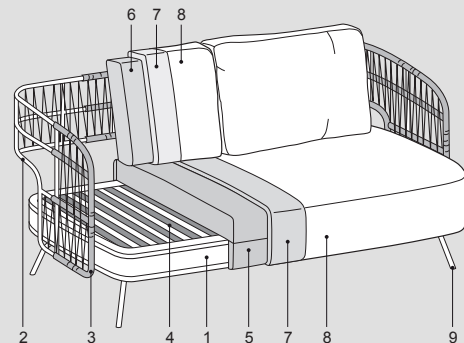
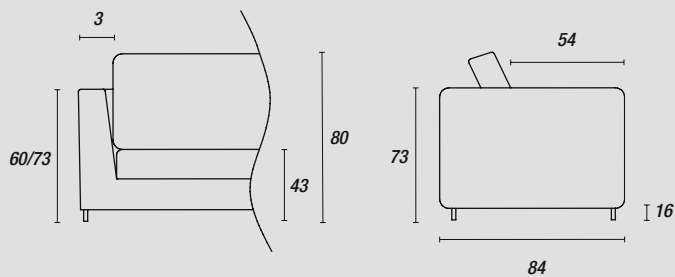

Gestell - Basamento:

serienmäßig GESTELL

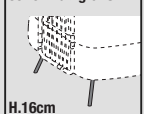

H.16cm

Light Brown (ME11)





Seilfarbe

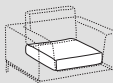
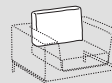

Band grau C001

356 outdoor Decke

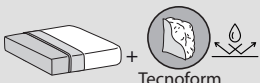

	 Sitzkissen - <i>Seduta</i>	 Rückenkissen - <i>Schienale</i>	
Bezug: Rivestimento (8)	abziehbar <i>Sfoderabile</i>		
	nicht abziehbar <i>Non sfoderabile</i>	—	—
Polsterungen Imbottiture (5-6-7)	 D.30kg/m³	 D.18kg/m³	

TECHNISCHE BESCHREIBUNG

Gestell: 1-2-3

Struktur aus mehrschichtigen Tischlerplatten und Massivholzplatten mit Okume in verschiedenen Stärken.

Federung: 2-3-4

Rohrförmige Rückenlehne aus lackiertem Metall mit Outdoor-Behandlung. Sitzfläche mit elastischen Gurten aus Propylenfaser und Latex.

Hinweis

Vorbezug aus atmungsaktivem, wasserabweisendem Material. Heißversigelter wasserabweisender Bezug auf Anfrage erhältlich (technische Daten siehe Seite Materialien, Oberflächen und Warnhinweise).

INFORMAZIONI TECNICHE

Struttura: 1-2-3

Struttura in pannelli di legno listellare multistrato e masselli portanti in okume' di vari spessori.

Molleggio: 2-3-4

Schienale tubolare in metallo verniciato con trattamento outdoor. Seduta in nastri elastici di fibra propilenica e lattice.

Note:

Prefodera in materiale idrorepellente traspirante. Disponibile a richiesta cover idrorepellente termosaldada (per specifiche tecniche vedi pagina materiali, finiture e avvertenze).

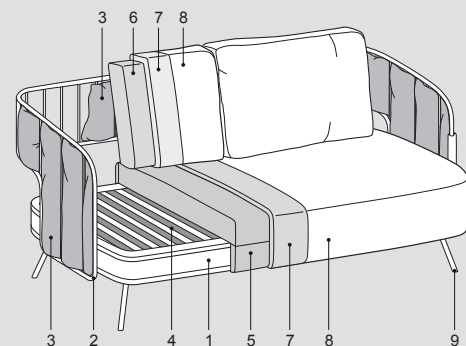
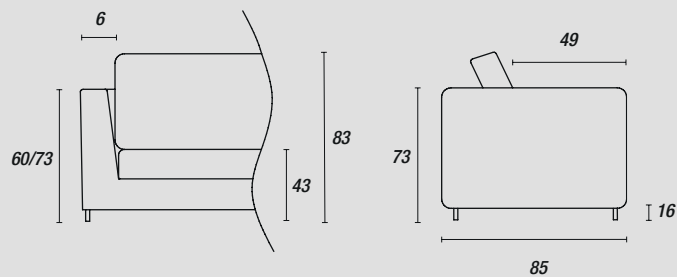

Gestell - Basamento:

serienmäßig GESTELL

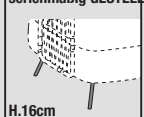

H.16cm
Light Brown (ME11)