









Sanders air outdoor



	 Basi - Bases	 Schienali - Backrests	
Rivestimento Upholstering (10)	Sfoderabile Removable 	Sfoderabile Removable 	Sfoderabile Removable 
	Non sfoderabile Not removable —	Non sfoderabile Not removable —	Non sfoderabile Not removable —
Imbottiture Padding (3-4-5-6-7-8-9)	 D.35kg/m³	 D.75/25kg/m³+zavorra	

INFORMAZIONI TECNICHE

Struttura: 1

Masselli portanti in legno okume' di vari spessori. Fianchi di tamponamento in pannelli di legno listellare multistrato di okume'.

Basamento in metallo verniciato con trattamento outdoor.

Tavolini con basamento in metallo verniciato con trattamento outdoor e piano in legno iroko.

Molleggio: 2

Seduta in nastri elastici di fibra propilenica e lattice.

Note:

Prefodera in materiale idrorepellente traspirante.

Disponibile a richiesta cover idrorepellente termosaldata (per specifiche tecniche vedi pagina materiali, finiture e avvertenze).

Disponibile a richiesta cover idrorepellente termosaldata (per specifiche tecniche vedi pagina finiture).

TECHNICAL INFORMATION

Structure: 1

Load-bearing blocks in okumè wood of various thicknesses. Infill sides in okumè multilayer blockboard wood.

Base in painted metal with outdoor treatment.

Coffee tables with base in painted metal with outdoor treatment and top in iroko wood.

Springing: 2

The seat is supported by propylene and latex elastic belts.

Notes:

Pre-lining in breathable water-repellent material.

Heat-sealed water-repellent cover available upon request (for technical specifications see Materials, Finishes and Warnings page).

Heat-sealed water-repellent cover available upon request (for technical specifications see Finishes page).

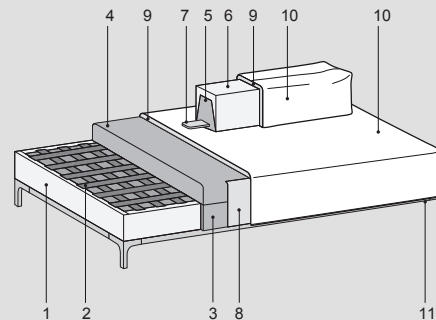
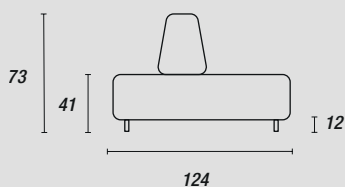

Basamento: - Base::



Light brown (ME11)

Accessori - Accessories:



Iroko (LE20)