

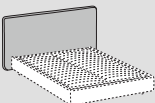

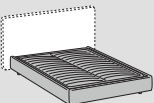





# Avalon



	 Testiera - Headboard	 Giroletto - Bed frame		
<b>Rivestimento Upholstering (10)</b>	Sfoderabile Removable  	Sfoderabile Removable  		
	Non sfoderabile Not removable -	Non sfoderabile Not removable -		
<b>Imbottiture Padding (6-7-8-9)</b>	 +  D.21-30-40kg/m <sup>3</sup>	 +  D.30kg/m <sup>3</sup>		

## INFORMAZIONI TECNICHE

### Struttura: (1-2-3-4-5)

Testiera in pannelli di legno multistrato in classe E1, legno di abete e pannelli di faesite; longoni e pediera in pannelli di legno multistrato in classe E1, legno di abete e pannelli di faesite.

### Note:

Inserti nella testiera e nel giroletto in tessuto Tallin o Malaga.

Possibilità di regolare l'altezza della rete su cui appoggia il materasso.

Caratteristiche relative ai materiali utilizzati descritte nella sezione tecnica a fine listino. Coprirete disponibile nella sezione accessori per letti.

## TECHNICAL INFORMATION

### Structure: (1-2-3-4-5)

Headboard made of class E1 multilayer wood, fir wood and faesite panels; side rails and footboard made of class E1 multilayer wood, fir wood and faesite panels.

### Note:

Headboard and bed-ring inserts in Tallin or Malaga fabric.

Height-adjustment option for the bedbase that supports the mattress, allowing total or partial integration.

For characteristics of the used materials, see the technical section. Bed-base cover set available in the section "Bed accessories"

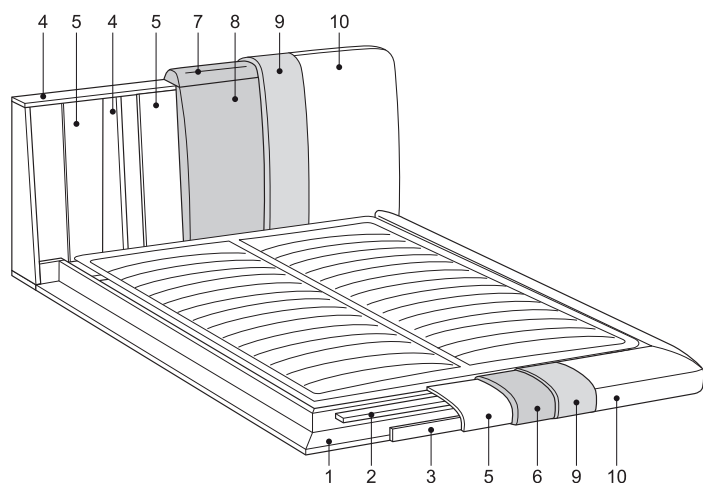

Versioni disponibili (per dimensioni selezionate)  
Available versions (by selected dimensions)

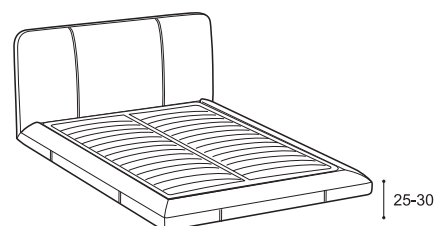







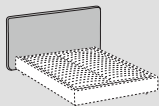
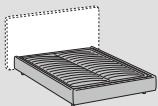

Disponibile per materasso da:  
Available for mattress:



# Avalon mix

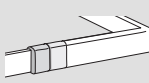

	 Testiera - Headboard	 Giroletto - Bed frame		
<b>Rivestimento</b> <b>Upholstering</b> (10)	Sfoderabile Removable  / 	Sfoderabile Removable  / 		
	Non sfoderabile Not removable -	Non sfoderabile Not removable -		
<b>Imbottiture</b> <b>Padding</b> (6-7-8-9)	 +  D.21-30-40kg/m <sup>3</sup>	 +  D.30kg/m <sup>3</sup>		

## INFORMAZIONI TECNICHE

### Struttura: (1-2-3-4-5)

Testiera in pannelli di legno multistrato in classe E1, legno di abete e pannelli di faesite; longoni e pediera in pannelli di legno multistrato in classe E1, legno di abete e pannelli di faesite.

### Note:

Inserti nella testiera in tessuto Tallin e Malaga, fascia perimetrale in pelle Polar. Possibilità di regolare l'altezza della rete su cui appoggia il materasso.

Caratteristiche relative ai materiali utilizzati descritte nella sezione tecnica a fine listino. Coprirete disponibile nella sezione accessori per letti.

## TECHNICAL INFORMATION

### Structure: (1-2-3-4-5)

Headboard made of class E1 multilayer wood, fir wood and faesite panels; side rails and footboard made of class E1 multilayer wood, fir wood and faesite panels.

### Note:

Headboard inserts in Tallin and Malaga fabric, perimeter band in leather Polar. Height-adjustment option for the bedbase that supports the mattress, allowing total or partial integration.

For characteristics of the used materials, see the technical section. Bed-base cover set available in the section "Bed accessories"

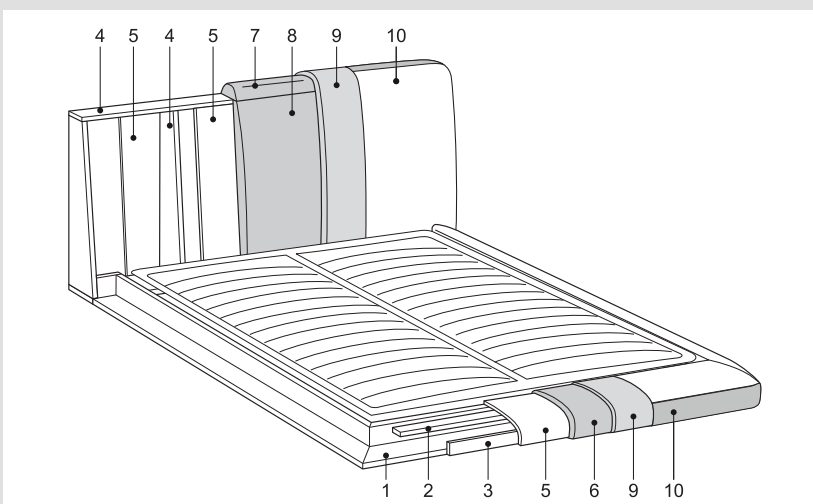

Versioni disponibili (per dimensioni selezionate)  
 Available versions (by selected dimensions)

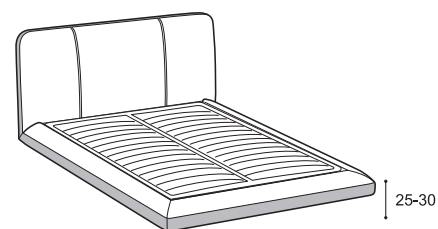

Disponibile per materasso da:  
 Available for mattress:

