

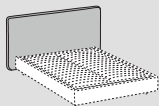

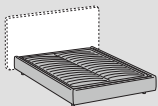







# Pacific

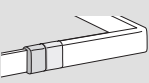

	 Testiera - Headboard	 Giroletto - Bed frame		
<b>Rivestimento Upholstering (8)</b>	Sfoderabile / Removable   	Sfoderabile / Removable   		
	Non sfoderabile / Not removable —	Non sfoderabile / Not removable —		
<b>Imbottiture Padding (5-6-7)</b>	 +  D.21-30-40kg/m³	 +  D.30kg/m³		

## INFORMAZIONI TECNICHE

### Struttura: (1-2-3-4)

Testiera in pannelli di legno multistrato in classe E1, legno di abete e pannelli di faesite; longoni e pediera in pannelli di particelle di legno (MDF) in classe E1, pannelli di osb, legno di abete e pannelli di faesite.

### Note:

Possibilita' di regolare l'altezza della rete su cui appoggia il materasso nei letti fissi privi di meccanismo.

Caratteristiche relative ai materiali utilizzati descritte nella sezione tecnica a fine listino.

Coprirete disponibile nella sezione accessori per letti.

## TECHNICAL INFORMATION

### Structure: (1-2-3-4)

Headboard made of class E1 multilayer wood, fir wood and faesite panels; side rails and footboard made of class E1 particle board (MDF), osb panels, fir wood and faesite panels.

### Note:

Height-adjustment option for the bedbase that supports the mattress, allowing total or partial integration for beds without mechanism.

For characteristics of the used materials, see the technical section.

Bed-base cover set available in the section "Bed accessories"

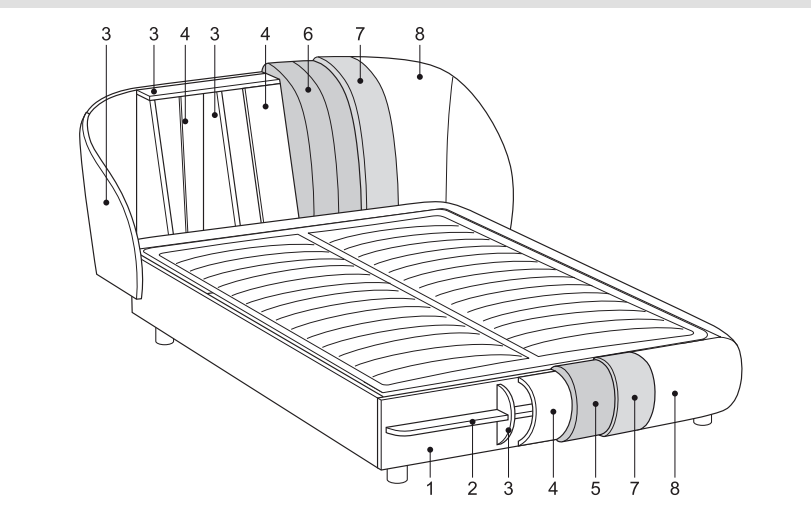

Versioni disponibili (per dimensioni selezionate)

Available versions (by selected dimensions)

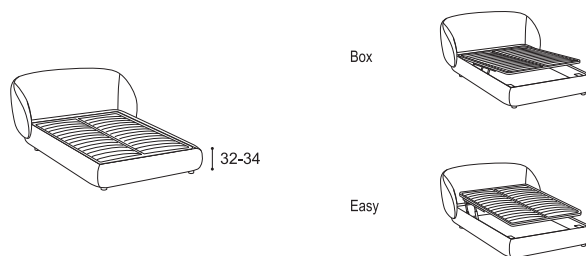







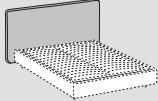
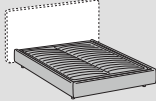

Disponibile per materasso da:  
Available for mattress:



# Pacific mix

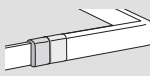

	 Testiera - Headboard	 Giroletto - Bed frame		
<b>Rivestimento Upholstering (8)</b>	Sfoderabile Removable  			
	Non sfoderabile Not removable -	-		
<b>Imbottiture Padding (5-6-7)</b>	 +  D.21-30-40kg/m <sup>3</sup>	 +  D.30kg/m <sup>3</sup>		

## INFORMAZIONI TECNICHE

### Struttura: (1-2-3-4)

Testiera in pannelli di legno multistrato in classe E1, legno di abete e pannelli di faesite; longoni e pediera in pannelli di particelle di legno (MDF) in classe E1, pannelli di osb, legno di abete e pannelli di faesite.

### Note:

Possibilita' di regolare l'altezza della rete su cui appoggia il materasso nei letti fissi privi di meccanismo.

Caratteristiche relative ai materiali utilizzati descritte nella sezione tecnica a fine listino. Coprirete disponibile nella sezione accessori per letti.

## TECHNICAL INFORMATION

### Structure: (1-2-3-4)

Headboard made of class E1 multilayer wood, fir wood and faesite panels; side rails and footboard made of class E1 particle board (MDF), osb panels, fir wood and faesite panels.

### Note:

Height-adjustment option for the bedbase that supports the mattress, allowing total or partial integration for beds without mechanism.

For characteristics of the used materials, see the technical section. Bed-base cover set available in the section "Bed accessories"

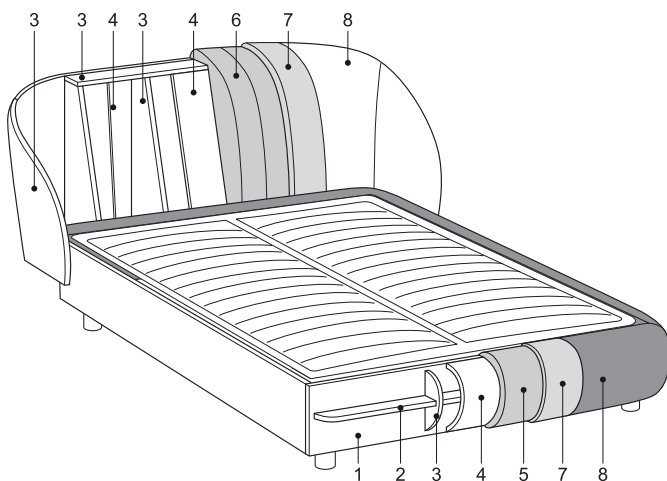

Versioni disponibili (per dimensioni selezionate)

Available versions (by selected dimensions)

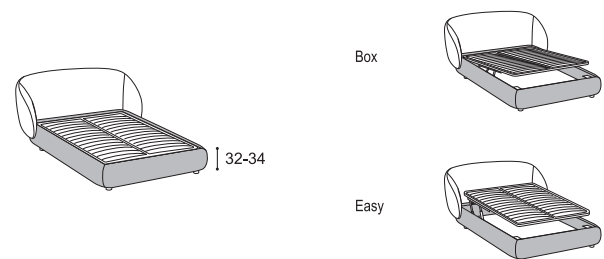

Disponibile per materasso da:  
Available for mattress:

